

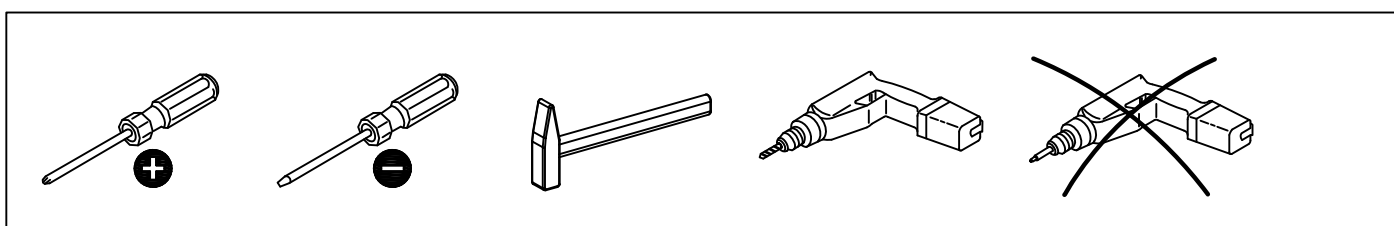

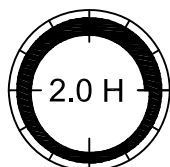

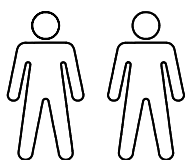

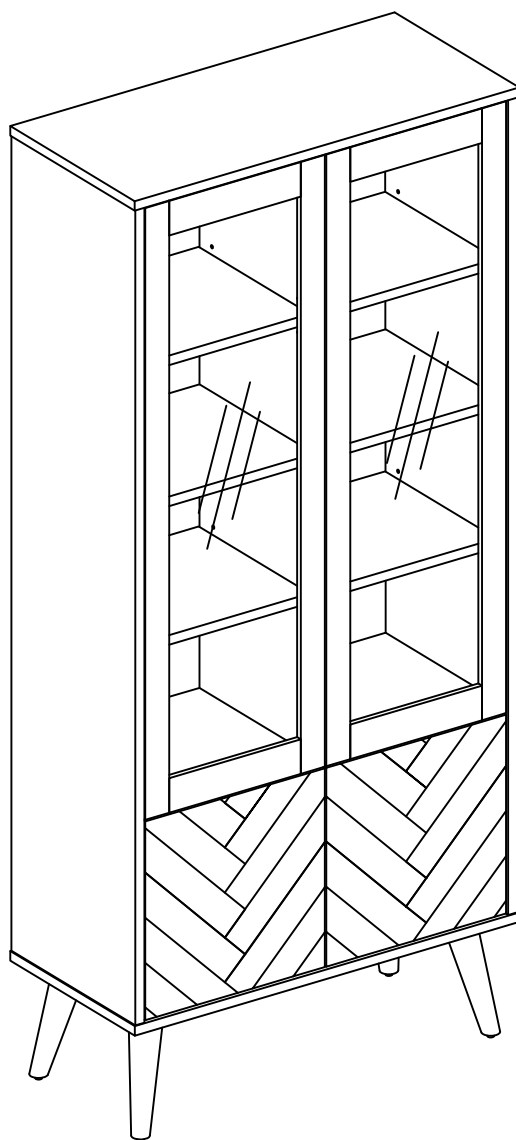

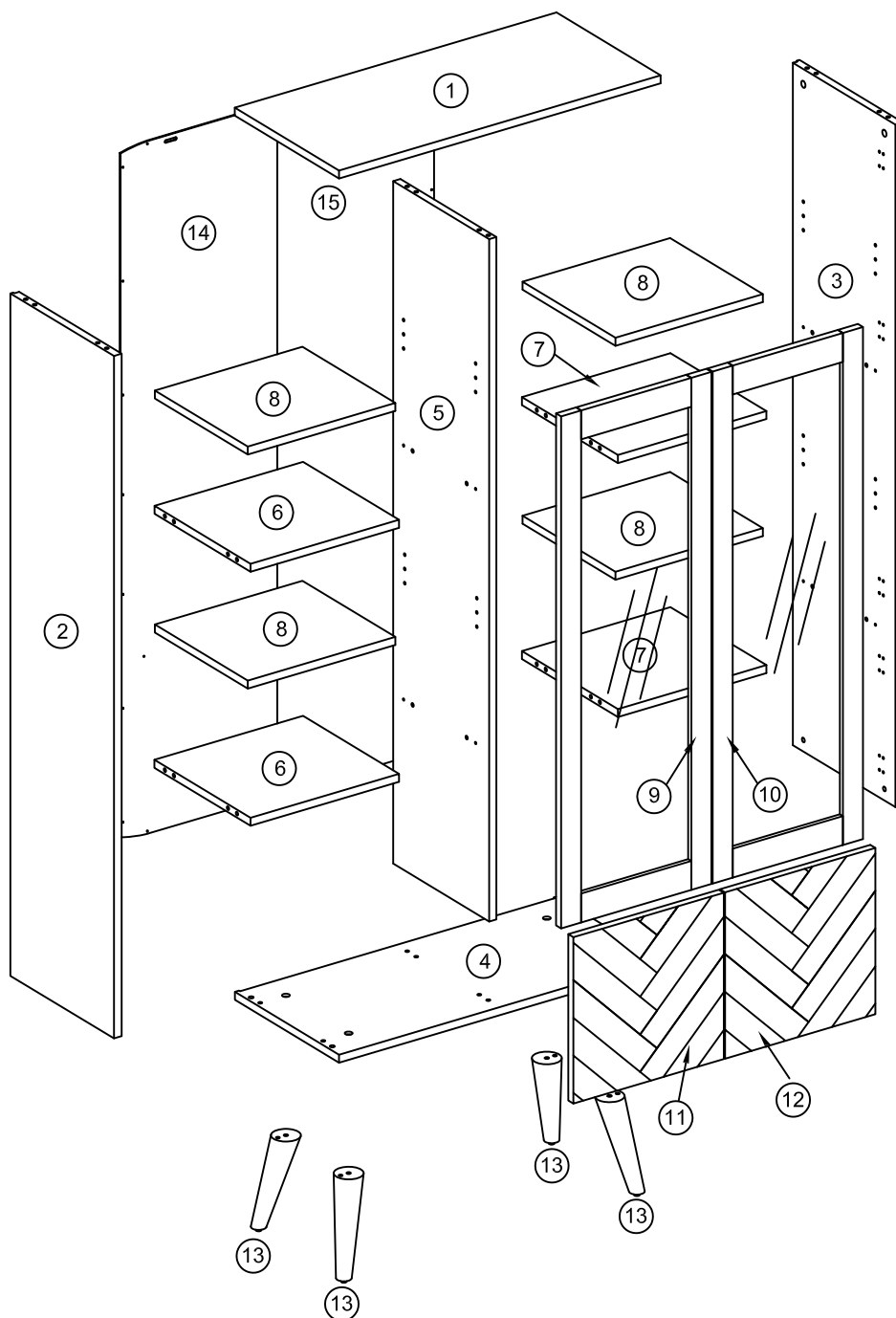

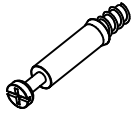

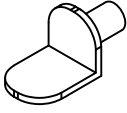
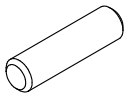

Nagano

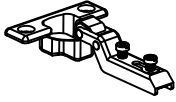
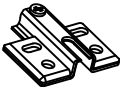
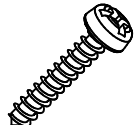

			✓
①	1	800 x 370 x 18	
②	1	800 x 370 x 18	
③	1	1534 x 368 x 18	
④	1	1534 x 368 x 18	
⑤	1	1534 x 341 x 18	
⑥	2	369.5 x 341 x 18	
⑦	2	369.5 x 341 x 18	

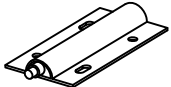
			✓
⑧	4	367 x 330 x 18	
⑨	1	1151 x 374 x 18	
⑩	1	1151 x 374 x 18	
⑪	1	374 x 374 x 18	
⑫	1	374 x 374 x 18	
⑬	4	230 x Ø60/Ø30	
⑭	1	1557 x 390 x 3	
⑮	1	1557 x 390 x 3	

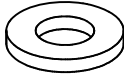

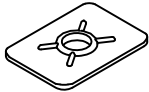
<p>A x 22</p>  <p>Ø6.5 x 43 mm</p>	<p>B x 22</p>  <p>Ø15 x 12 mm</p>	<p>C x 16</p>  <p>Ø6 mm</p>	<p>D x 32</p>  <p>Ø8 x 30 mm</p>	<p>E x 4</p>  <p>M6 x 40 mm</p>
<p>F x 4</p>  <p>Ø6/Ø16 mm</p>	<p>G x 4</p>  <p>M6</p>	<p>H x 78</p>  <p>Ø3.5 x 16 mm</p>	<p>J x 6</p>  <p>M6 x 50 mm</p>	<p>K x 10</p>  <p>Ø35 mm</p>
<p>L x 10</p> 	<p>M x 30</p>  <p>Ø3.5 x 16 mm</p>	<p>N x 1</p>  <p>4 mm</p>	<p>P x 6</p>  <p>Ø10 x 12 mm</p>	<p>Q x 4</p>  <p>90 x 45 mm</p>
<p>R x 4</p>  <p>Ø16 mm</p>	<p>S x 2</p>  <p>150 mm</p>	<p>T x 2</p>  <p>Ø4/Ø12 mm</p>	<p>U x 4</p>  <p>Ø 25 mm</p>	<p>V x 4</p>  <p>19 x 14 mm</p>

1

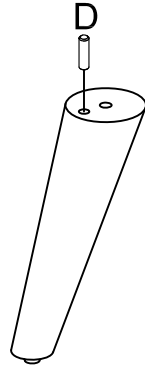
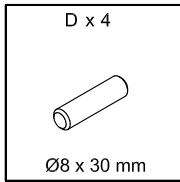



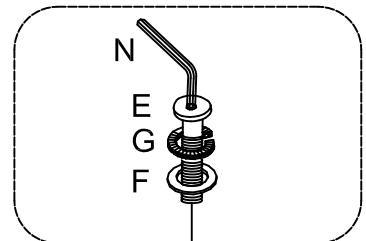
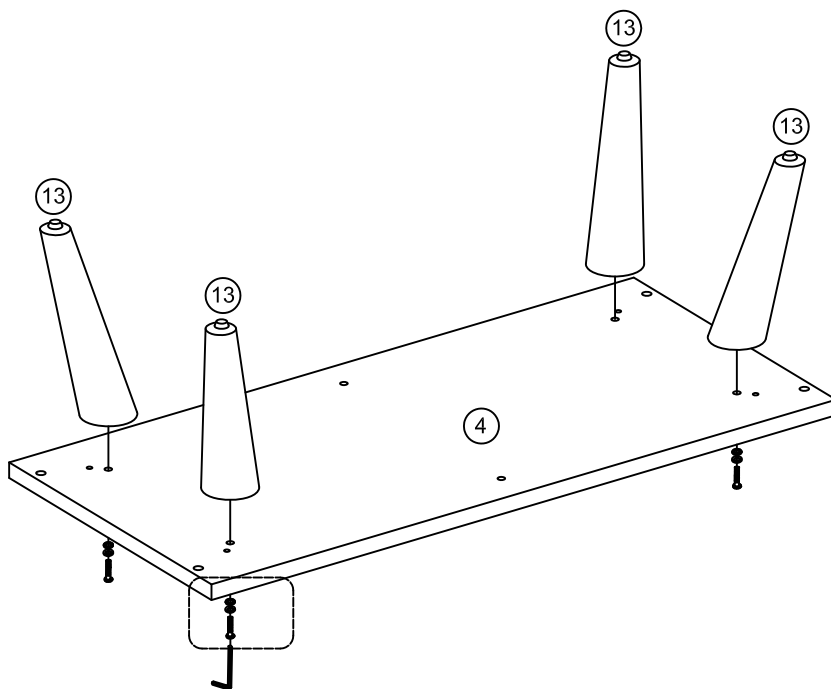
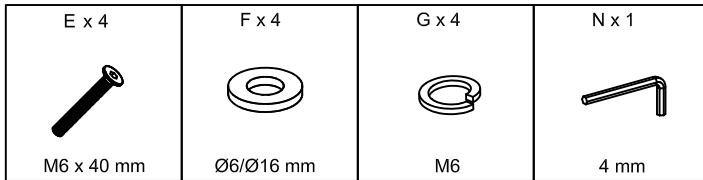

13 X4

2



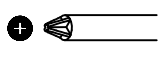

3

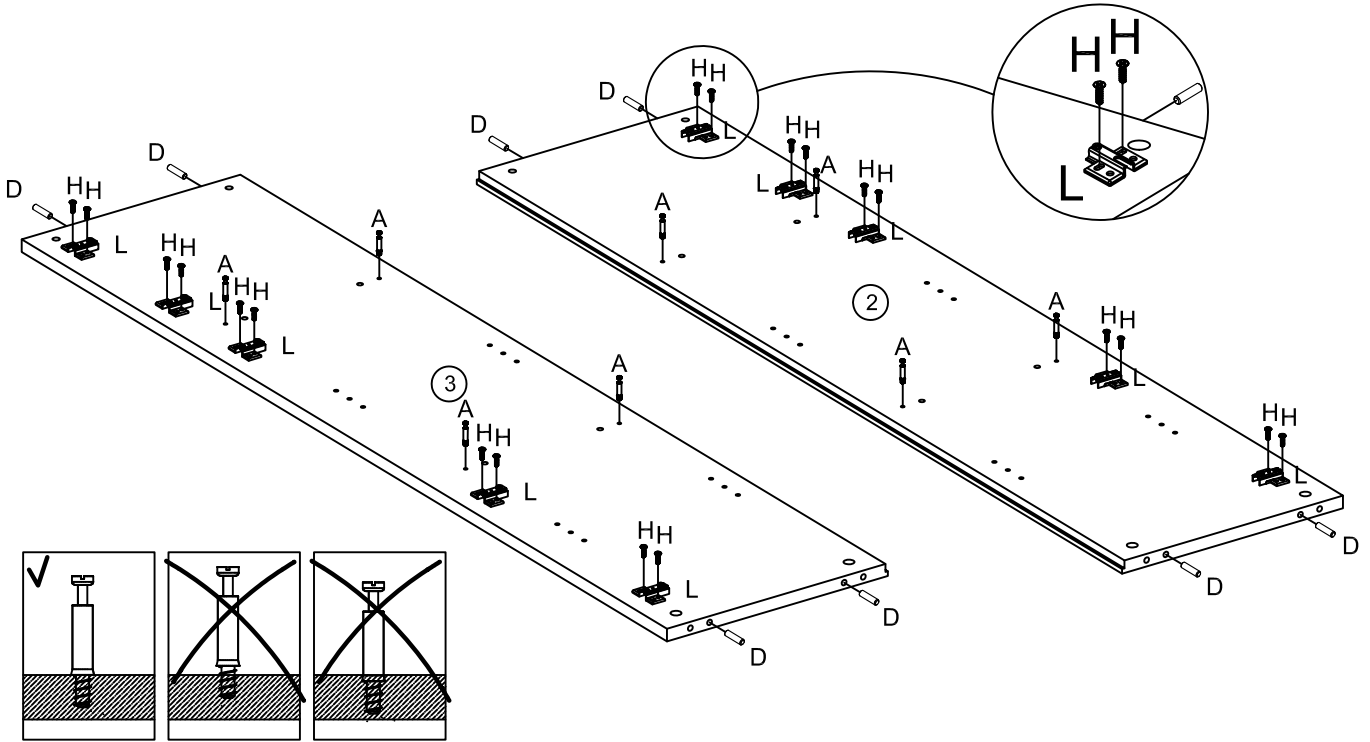
A x 8  Ø6.5 x 43 mm	D x 8  Ø8 x 30 mm	H x 20  Ø3.5 x 16 mm	L x 10 	
--	--	---	---	---



4

D x 16  Ø8 x 30 mm	
---	---

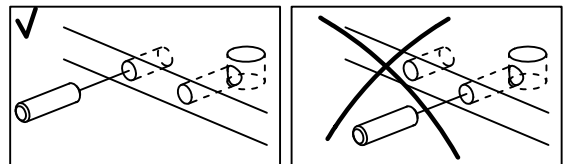
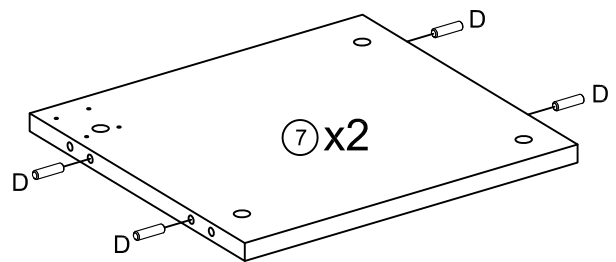
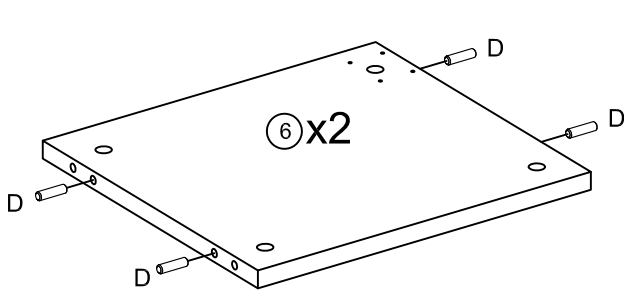

5

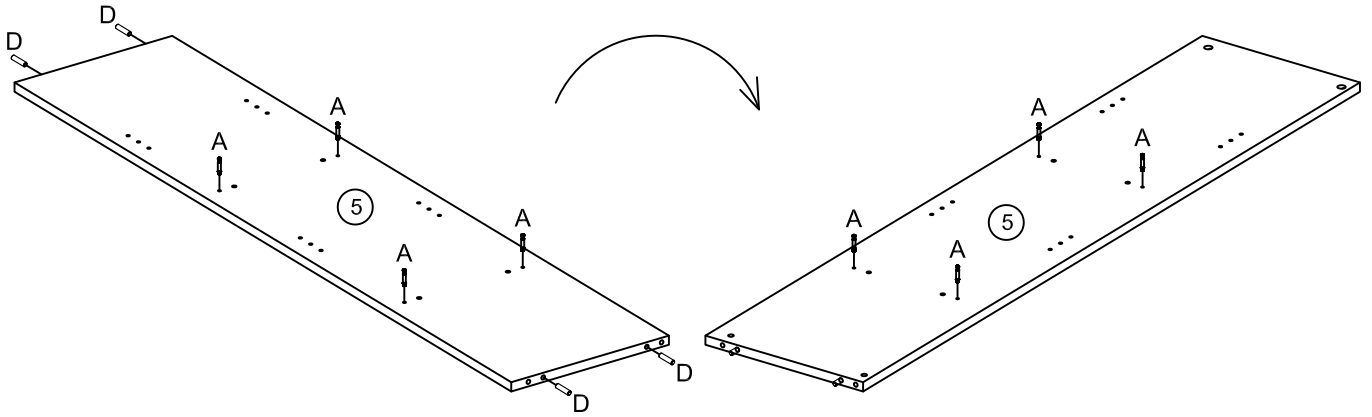
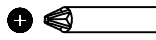
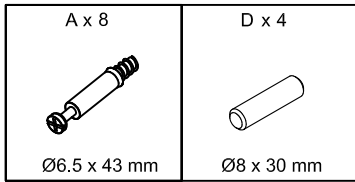

6

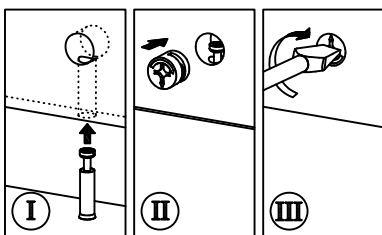
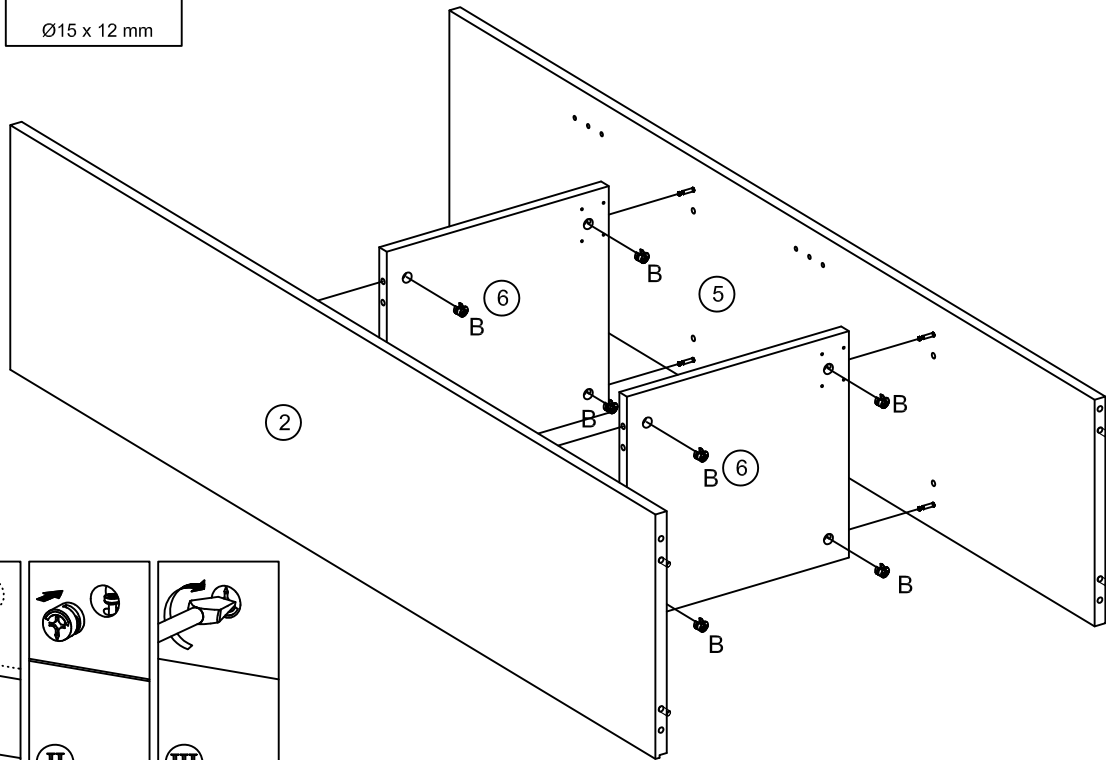
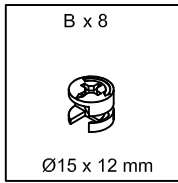



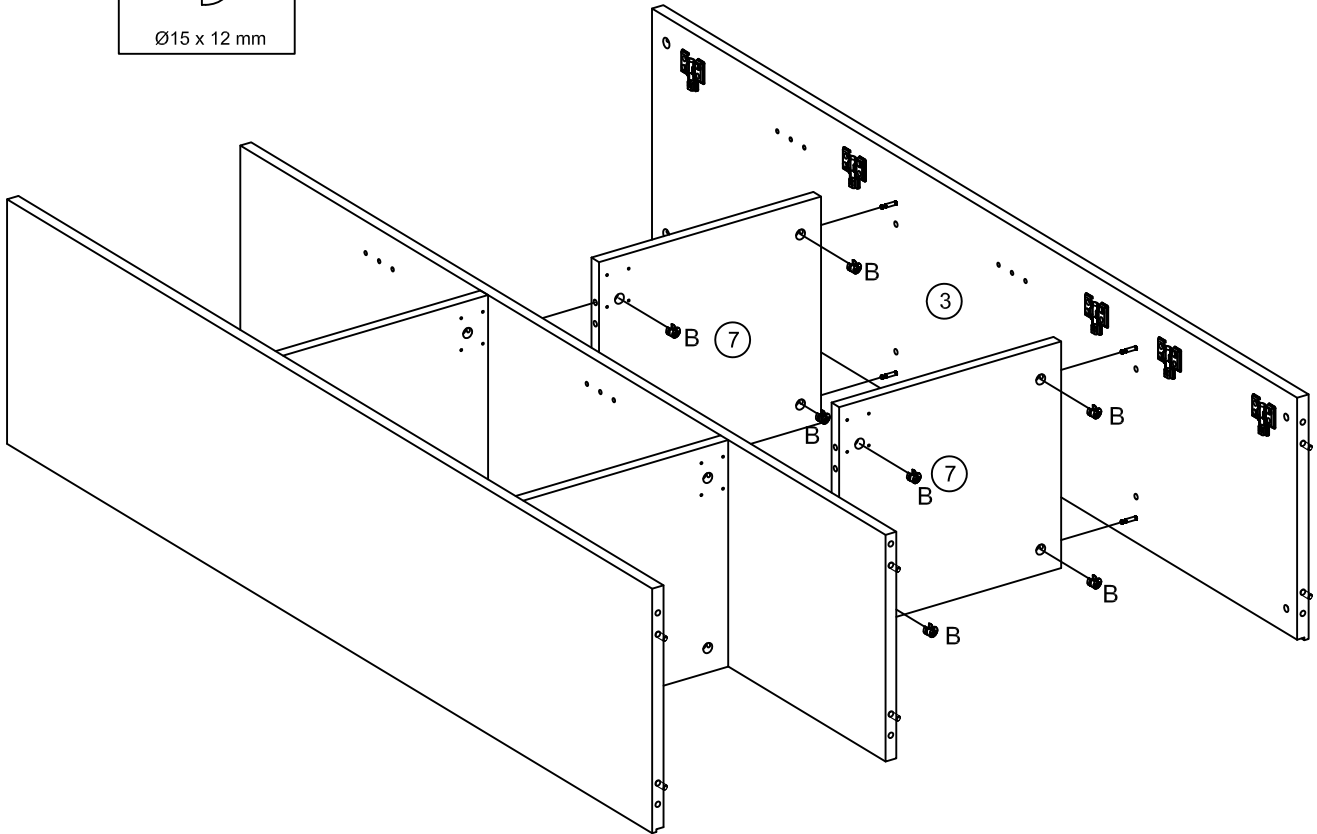
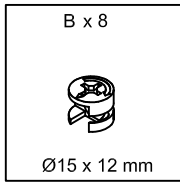

7

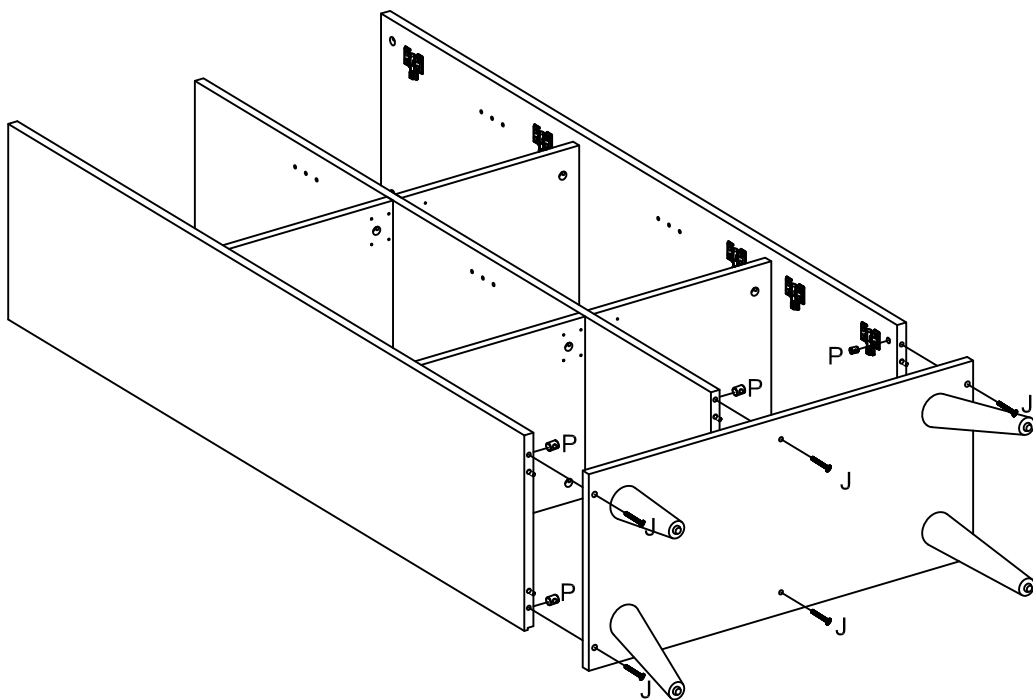
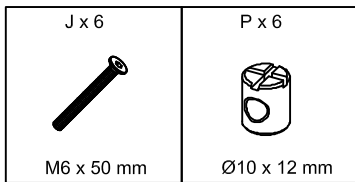

8



9

A x 6  Ø6.5 x 43 mm	H x 2  Ø3.5 x 16 mm	S x 2  150 mm	T x 2  Ø4/Ø12 mm
--	--	--	---

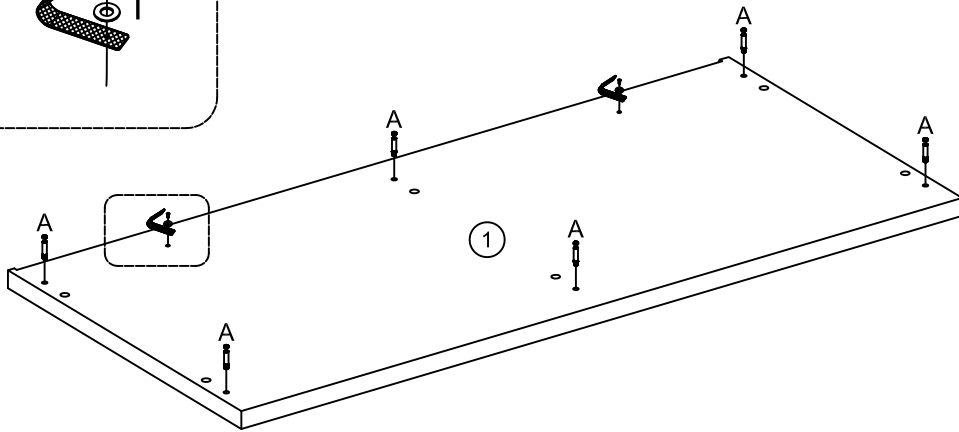
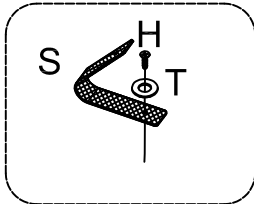

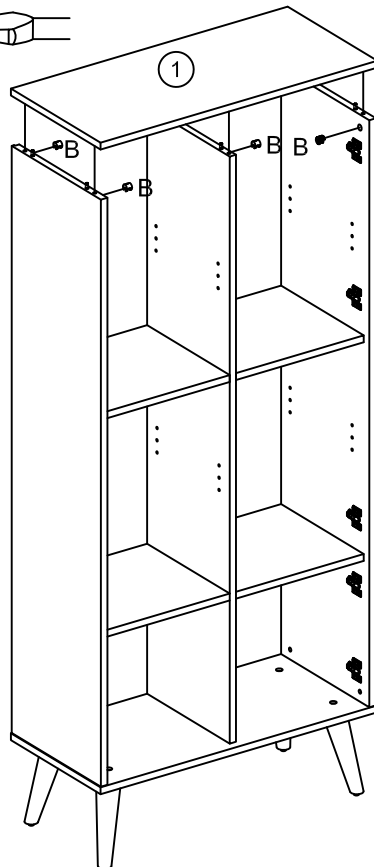

10

B x 6  Ø15 x 12 mm



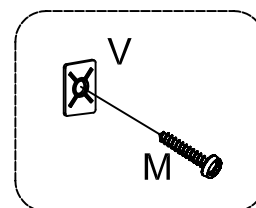
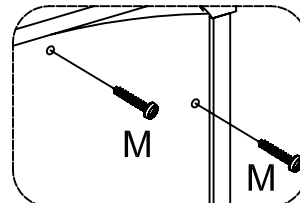
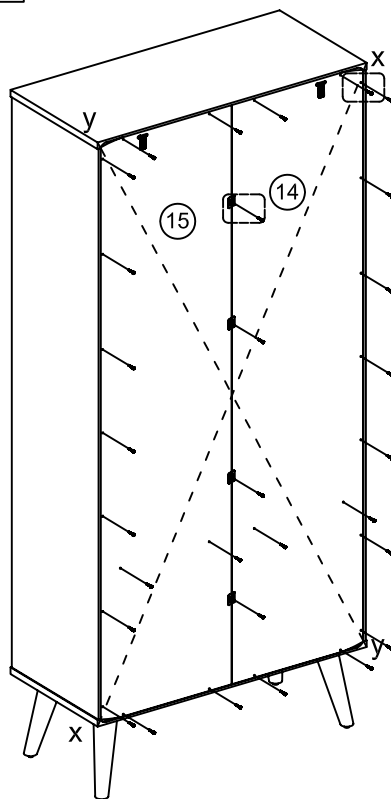
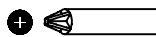

11

<p>M x 30</p>  <p>Ø3.5 x 16 mm</p>	<p>V x 4</p>  <p>19 x 14 mm</p>
---	--



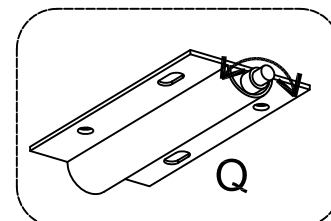
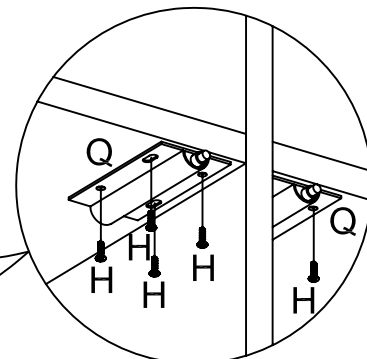
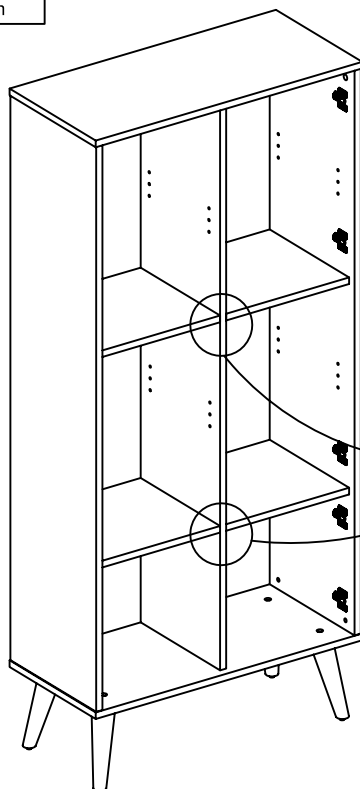

12

<p>H x 16</p>  <p>Ø3.5 x 16 mm</p>	<p>Q x 4</p>  <p>90 x 45 mm</p>
---	--



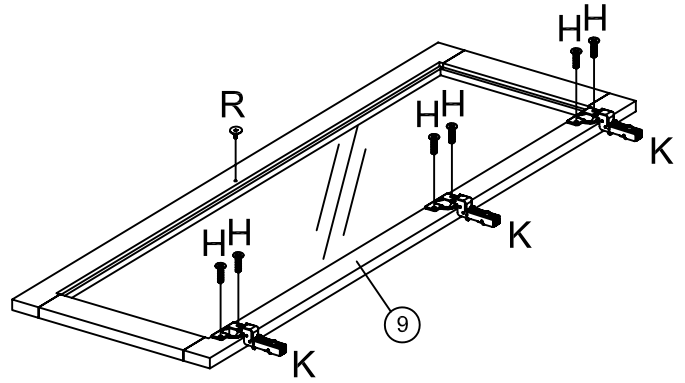
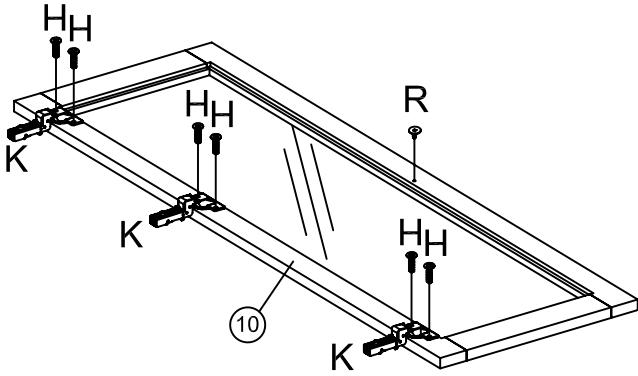

13

H x 12	K x 6	R x 2
		
Ø3.5 x 16 mm	Ø35 mm	Ø16 mm



14

H x 8	K x 4	R x 2
		
Ø3.5 x 16 mm	Ø35 mm	Ø16 mm

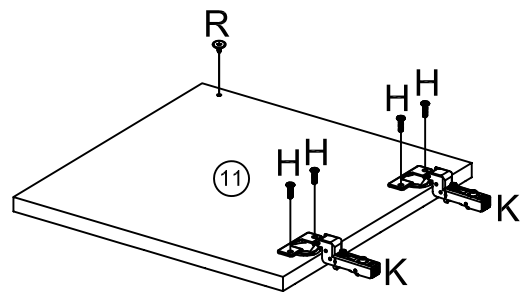
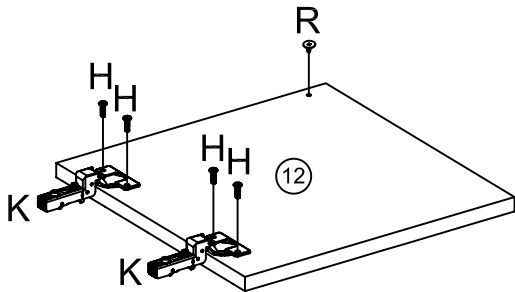
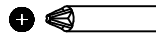

15

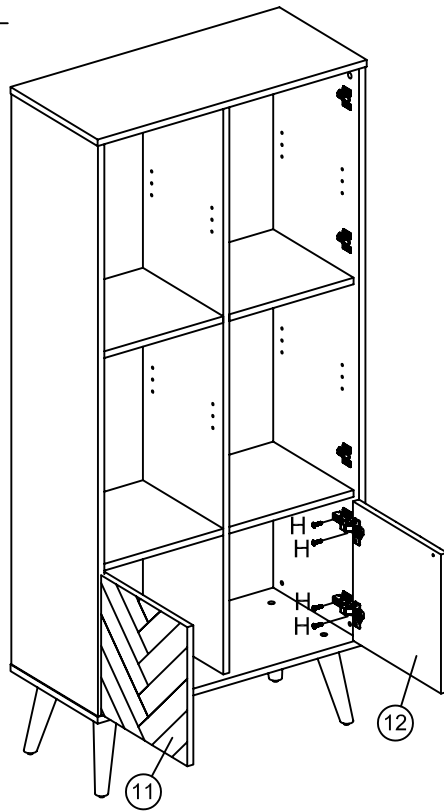
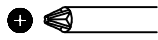
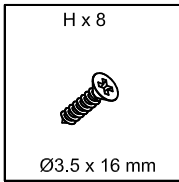

16

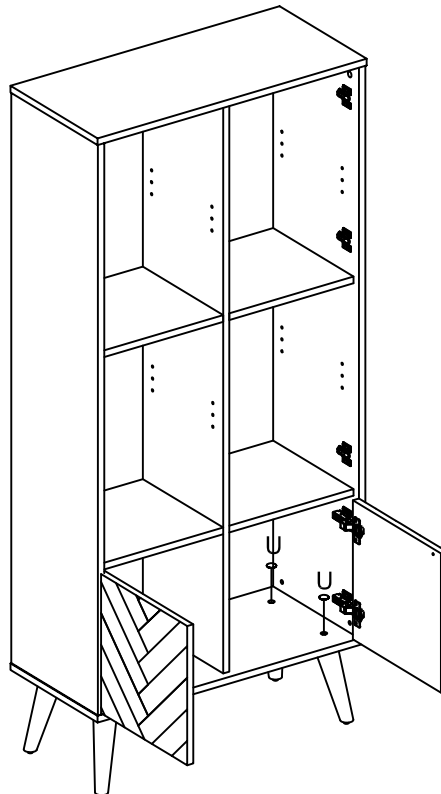
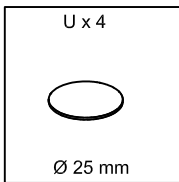

17

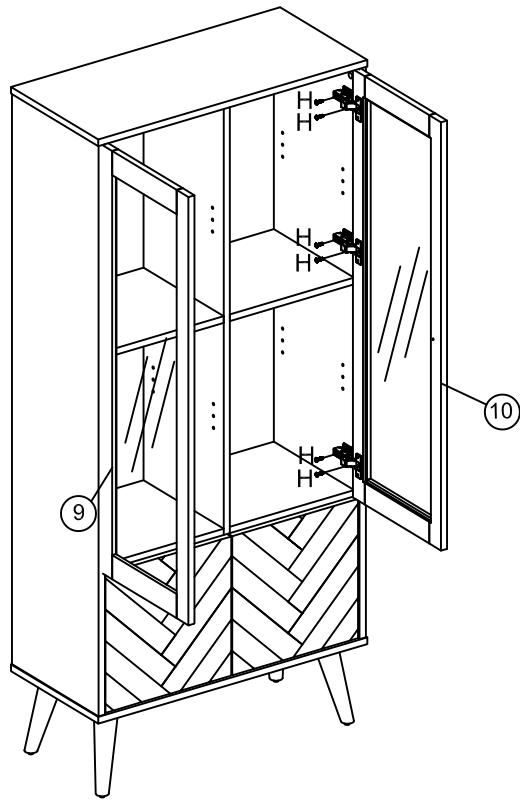
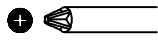
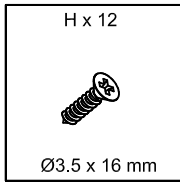

18

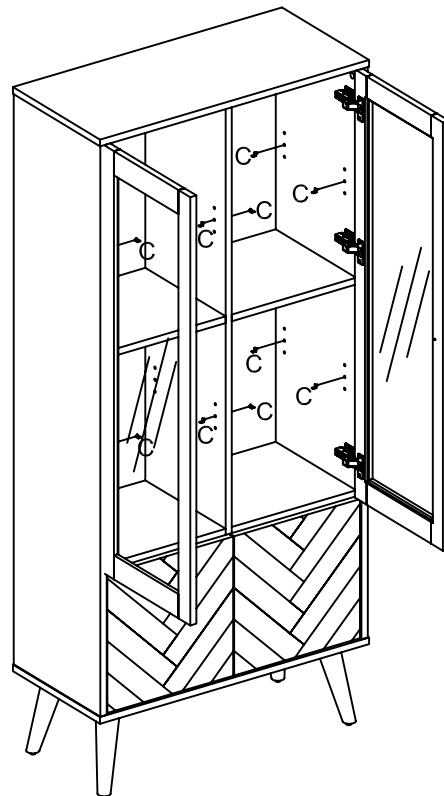
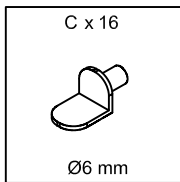

19

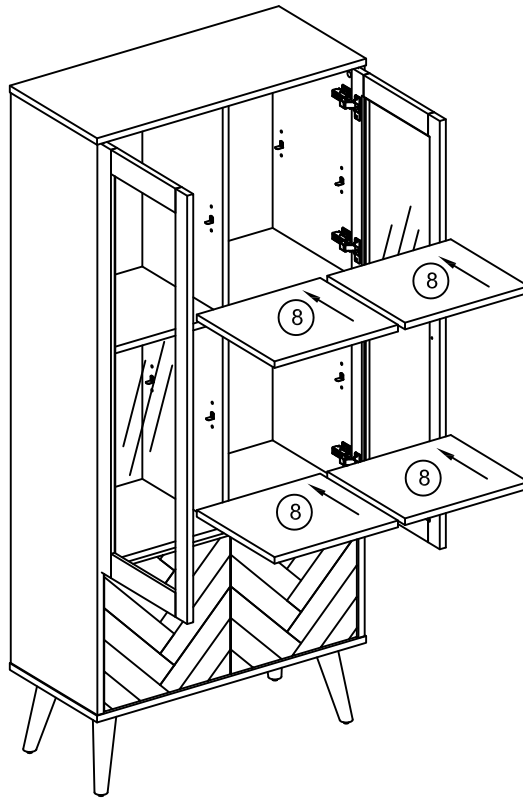

20

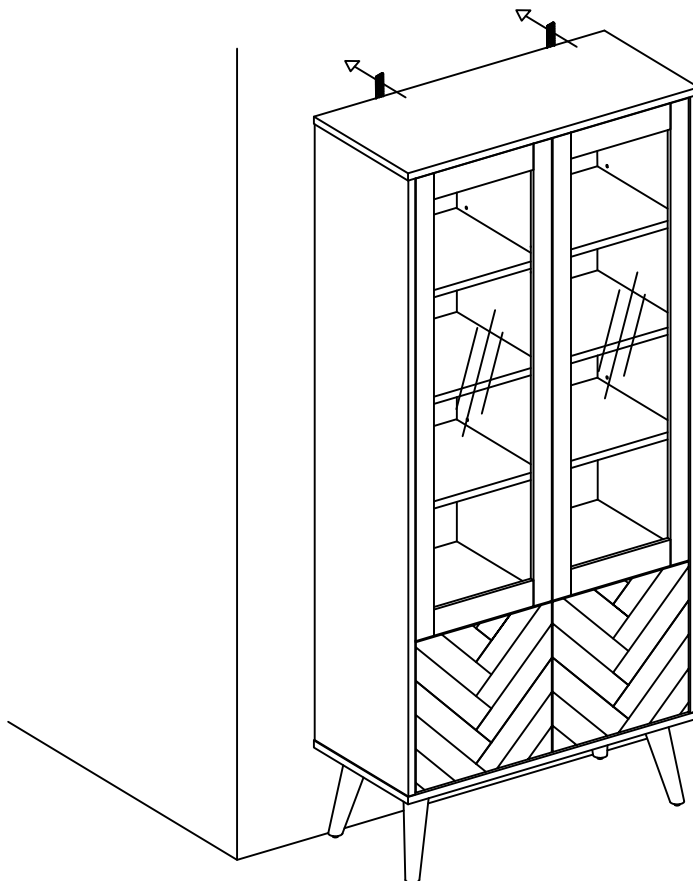

21

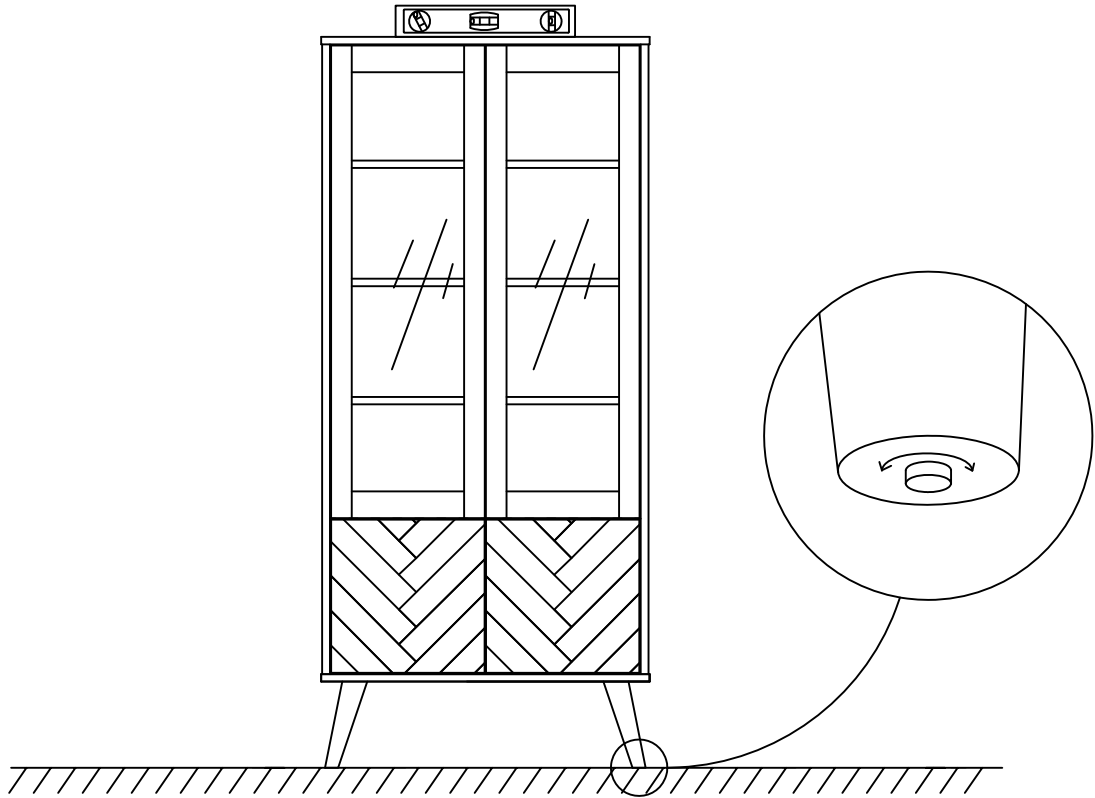
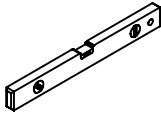

22

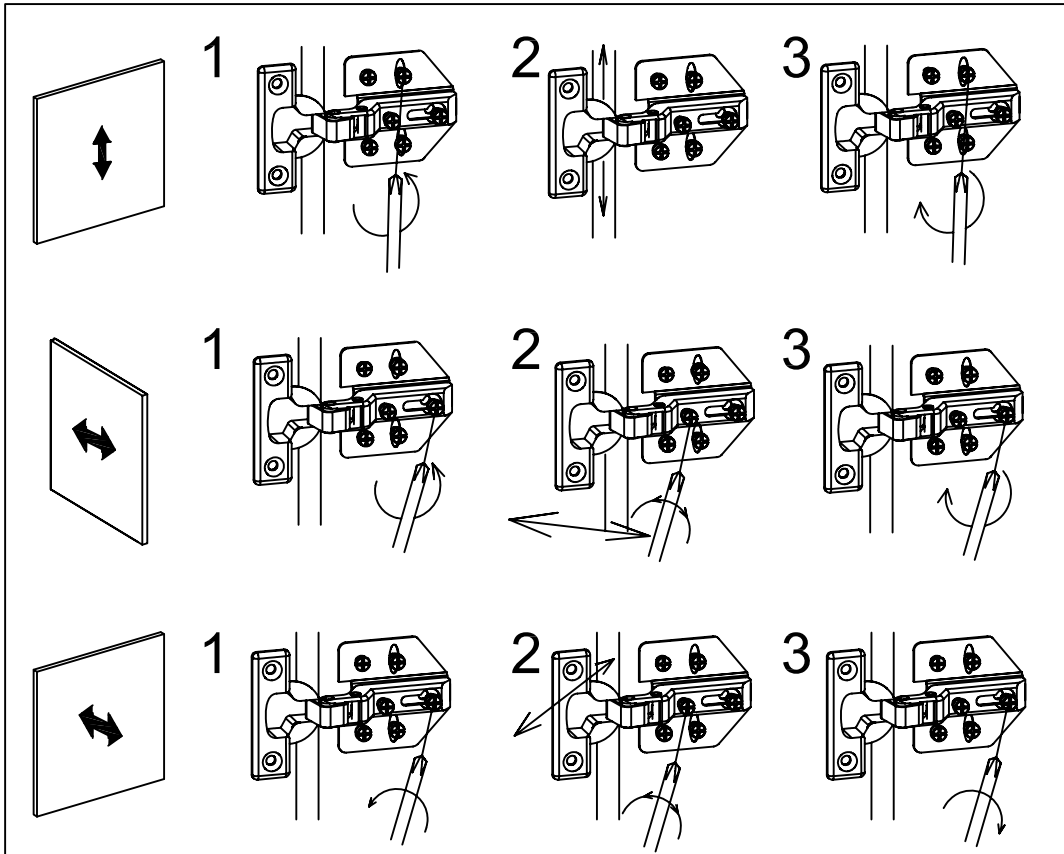

23

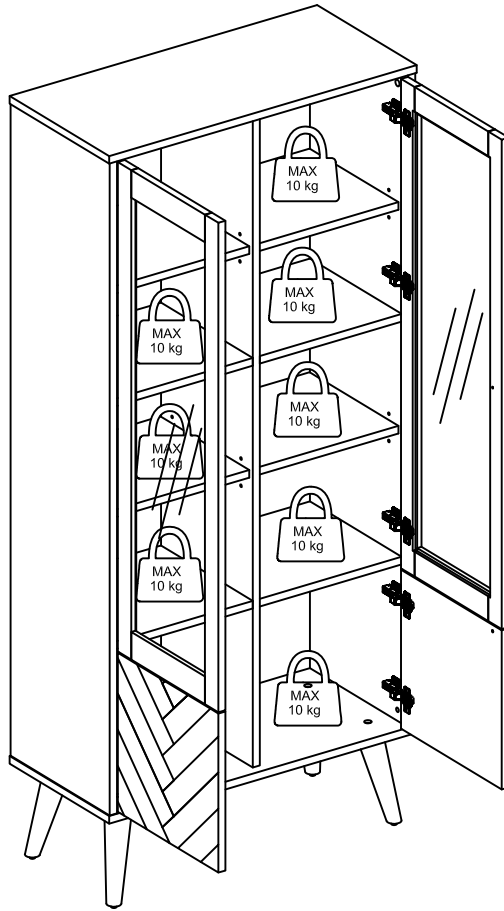

24

