

Assembly Instruction

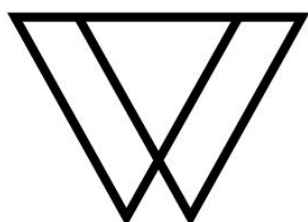

1480x1502x322



WOODMAN[®]
DESIGN FURNITURE FACTORY

Woodman OÜ

Made in Estonia
Mäo, Järvamaa
www.woodman.ee
support@woodman.ee

Reference no:

Dear Customer

Congratulations on your new purchase. Follow this advice and get the best result when assembling the product.

Read the instruction carefully before you start
Get help, If two persons are required for assembly
Make sure, you have all parts on the total material list
Work on a soft, flat surface to avoid any damage to the finish
Follow the assembly instruction
Tighten the furniture joints after a month
Keep the assembly instruction

Allocate time

Some furniture can be assembled in minutes. Others - e.g. products in several parts - can take more than an hour to finish. Make sure to allocate good time or divide up the work.

Tools needed

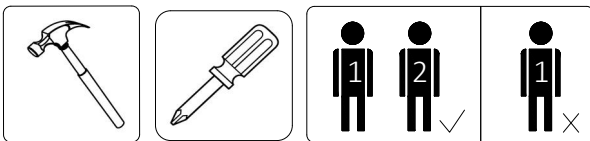

Don't use!!!

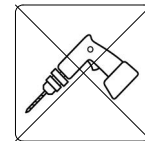

Total material list, furniture parts

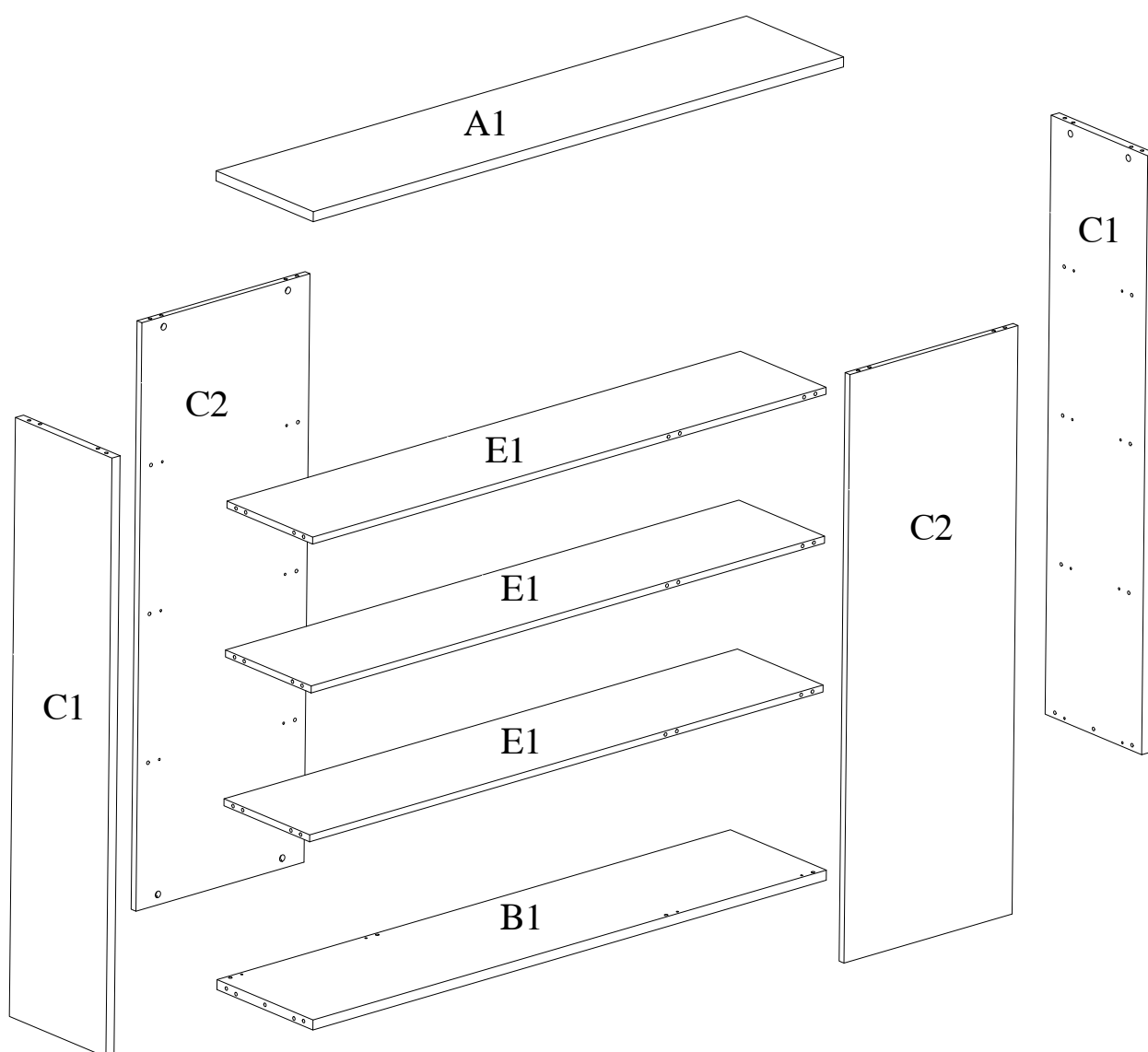

ENG - In case of any quality issues, contact your local dealer and always mention item reference No.

FR - En cas de problèmes de qualité, contactez votre revendeur local et mentionnez toujours la référence de l'article.

IT - In caso di eventuali problemi di qualità, contattare il rivenditore locale e citare sempre punto di riferimento No.

ES - En caso de problemas de calidad, póngase en contacto con su distribuidor local y mencione siempre la referencia del artículo.

DE - Wenn Sie Qualitätsprobleme haben wenden Sie sich bitte an ihren örtlichen Händler und erwähnen Sie immer die Artikelnummer.

Total material list, hardware

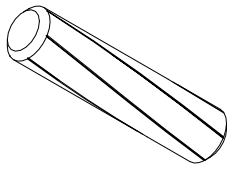

Ⓐx42

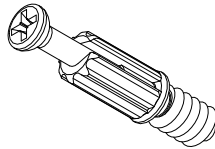

Ⓑx40

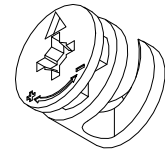

Ⓒx40

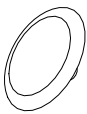

Ⓓx32 White



Ⓔ x4 Oak



Ⓕx16

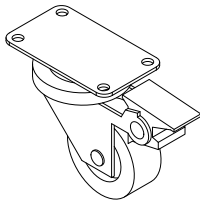

Ⓖx2

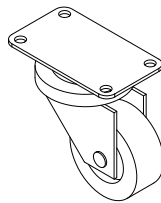

Ⓕx2

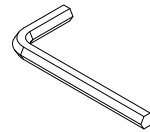

Ⓖx1

Assembly instructions, 1

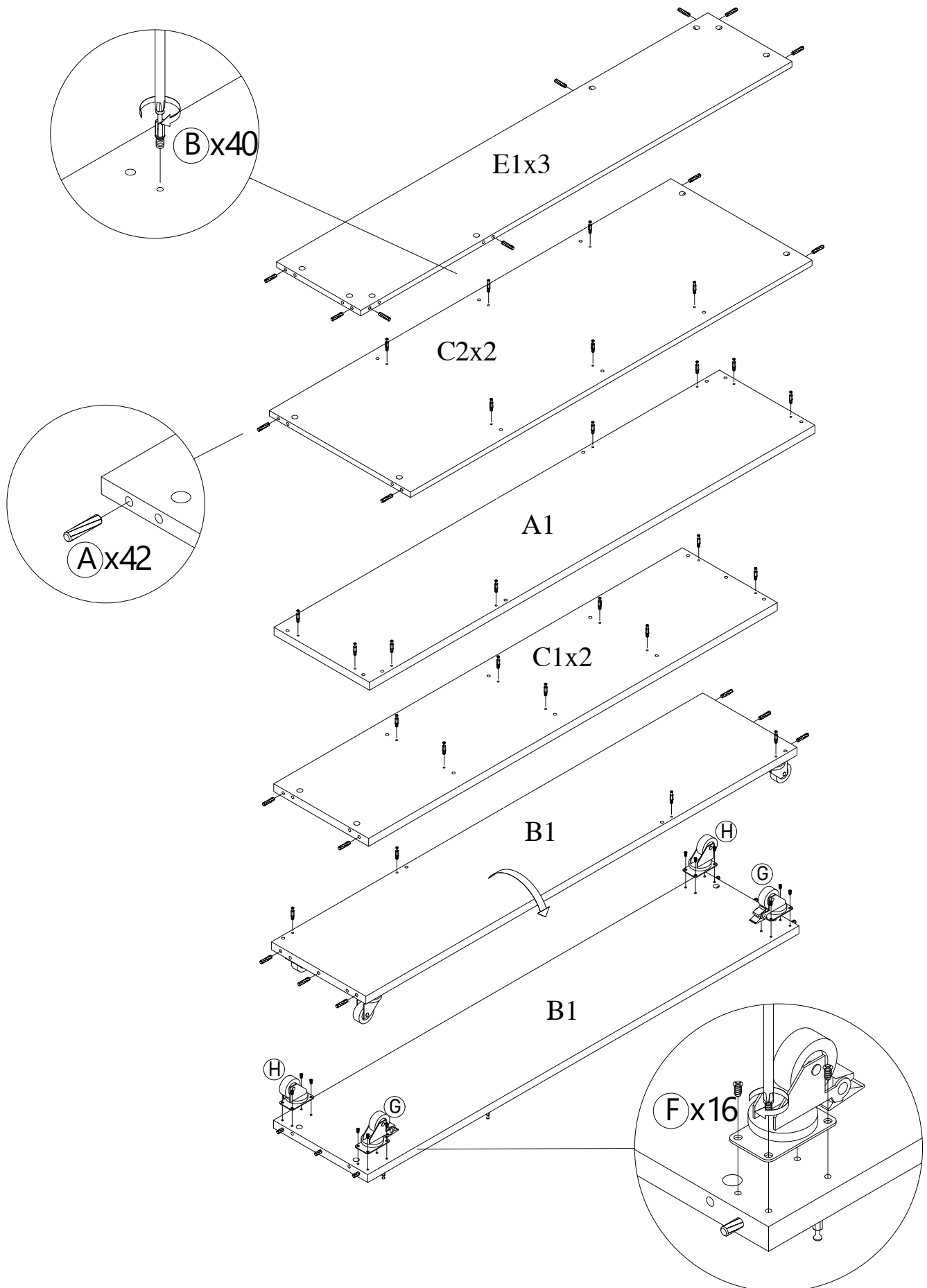

Assembly instructions, 2

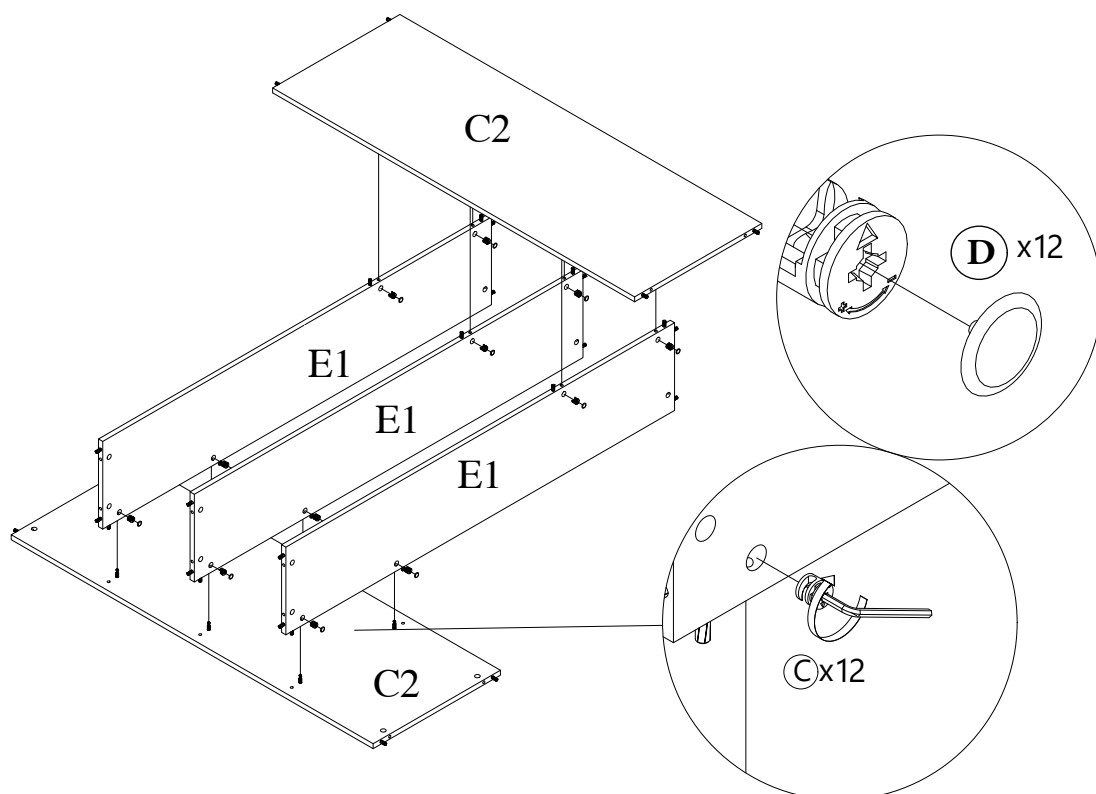

Assembly instructions, 3

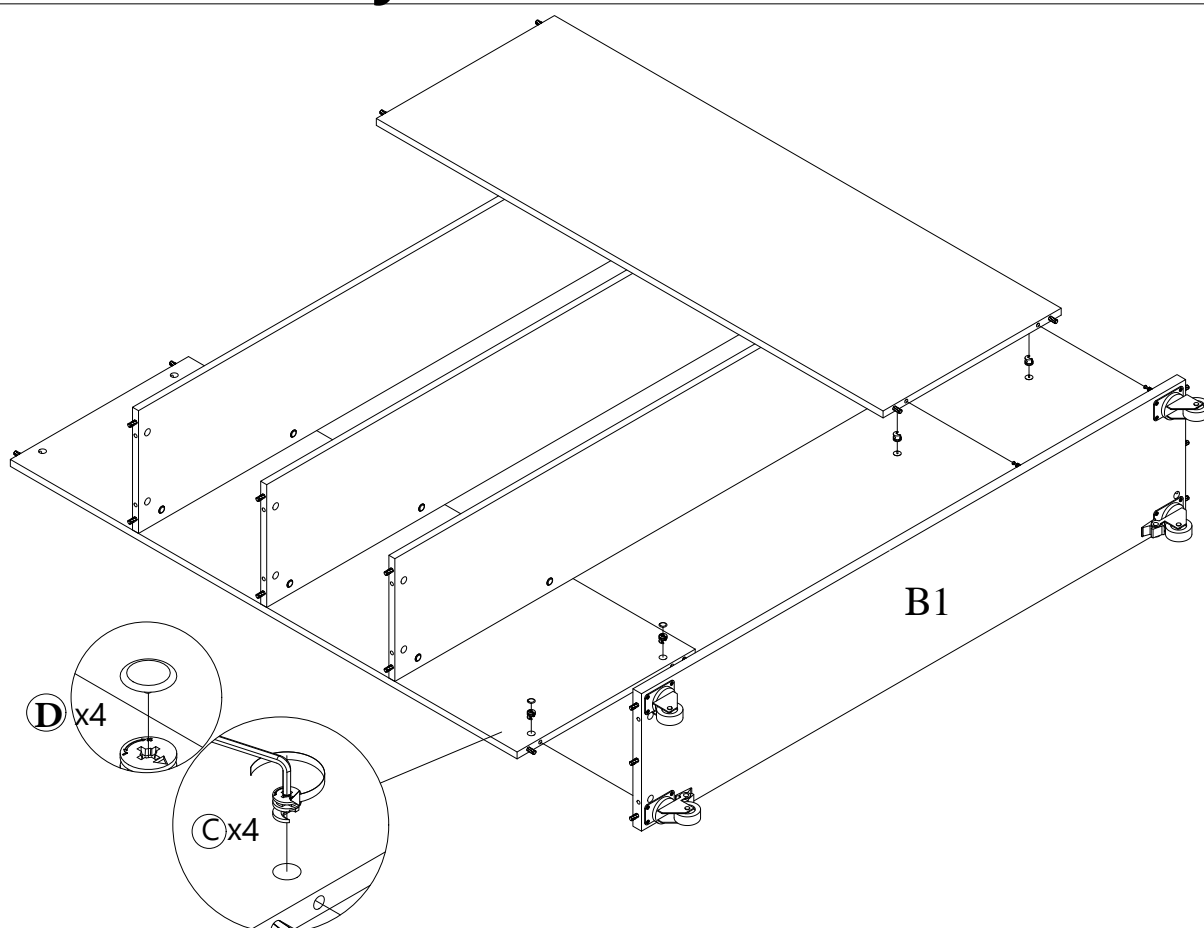

Assembly instructions, 4

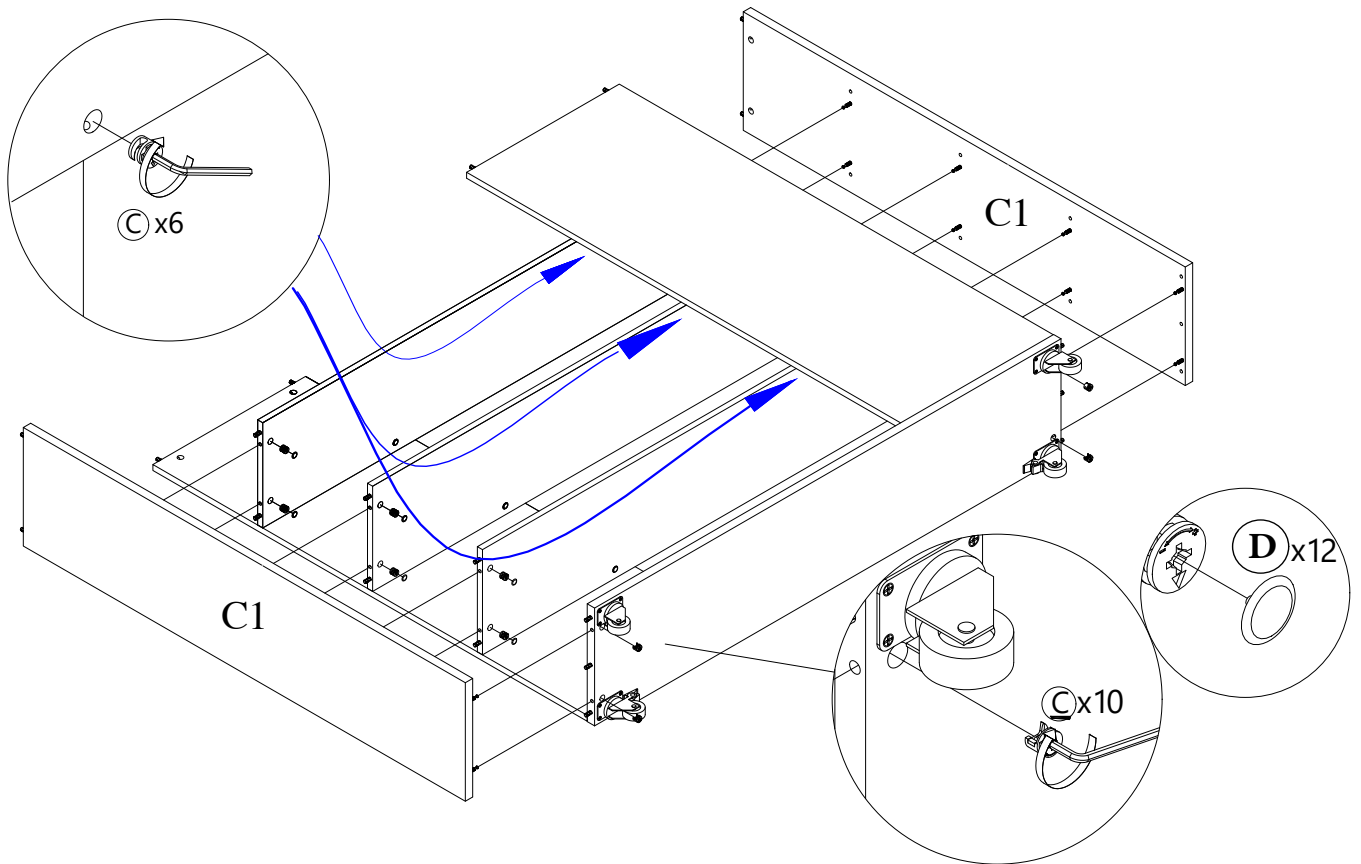

Assembly instructions, 4

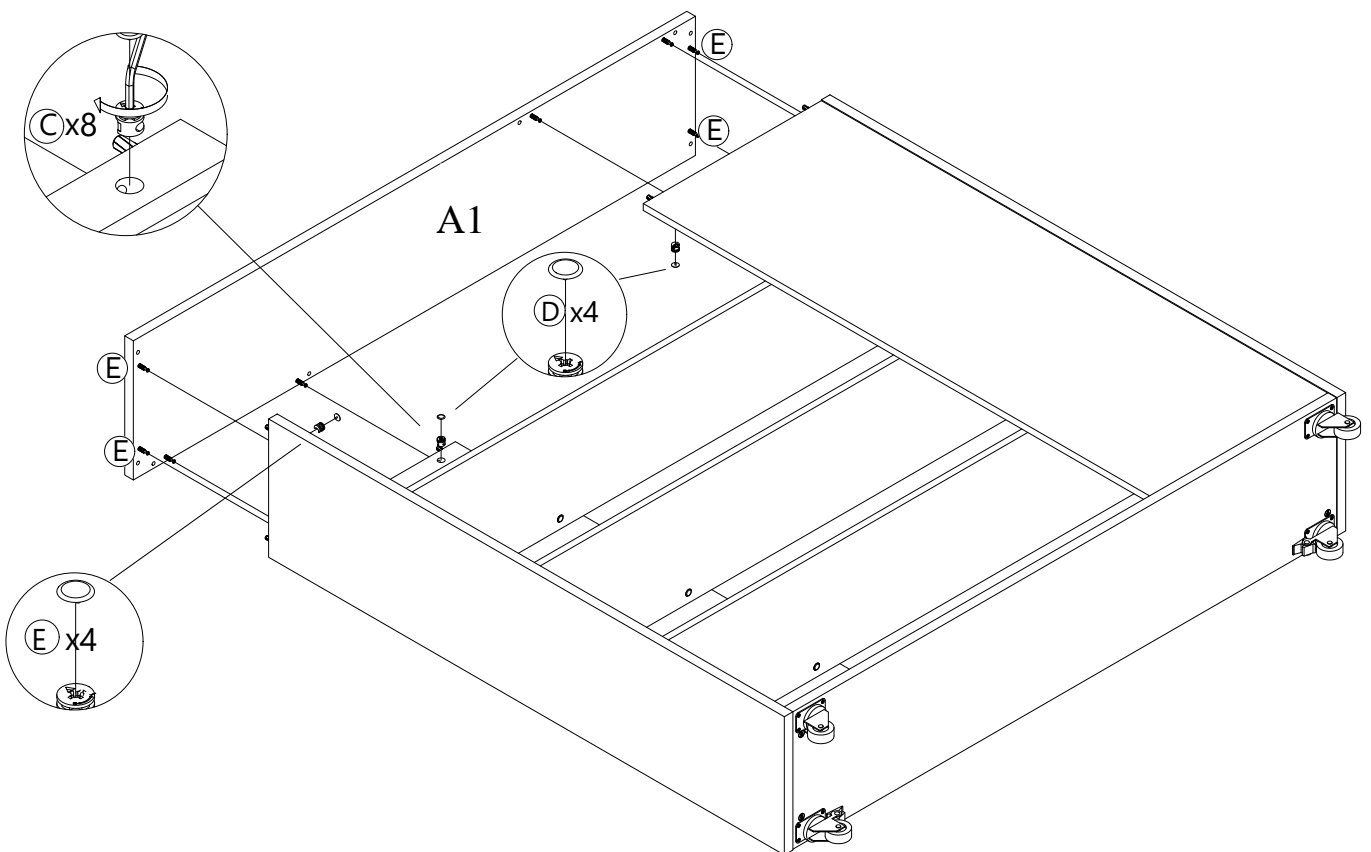

Safety and Care Advice

General care and maintenance

Only clean using a damp cloth and mild detergent, do not use bleach or abrasive cleaners.

From time to time check that there are no loose screws on this unit.

This product should not be discarded with household waste. Take to your local authority waste disposal centre.

Cleaning and care of lacquered surfaces

Regular dusting with a dry cloth will keep your units clean.

Clean marks with a damp cloth.

Do not use abrasive cleaners.

Do not clean with products containing following:

Acetone (e.g nail varnish remover). Ammonia (e.g.bleach) or Sodium hydroxid (e.g. Caustic soda, drain and oven cleaners) .

To remove stubborn stain, wipe over with damp cloth and washing up liquid.

In the event of accidental contact with aggressive cleaners, rinse thoroughly with water. Use place mats to protect the surface from moisture and heat.

Maximum weight limit

Important: Recommended maximum load for each shelf is shown below.

