

NOTICE DE MONTAGE
 ASSEMBLY INSTRUCTIONS
 MONTAGEANLEITUNG
 ISTRUZIONI DI MONTAGGIO
 INSTRUÇÕES DE MONTAGEM
 INSTRUCCIONES DE MONTAJE
 UPUTE ZA MONTAZU
 MONTAJ TALIMATI

14860 - 14878 - 15122

MUEBLE TV 2P2H
 MEUBLE TV 2P2N
 TV CABINET 2D2H

ME
 marckeric

MARCKERIC S.L.
 C / ENLACE VEROLA S/N,
 PC: 46430/SOLLANA / VALENCIA / SPAIN

EAN CODE

8435178385475
 8435178385628
 8435178388889

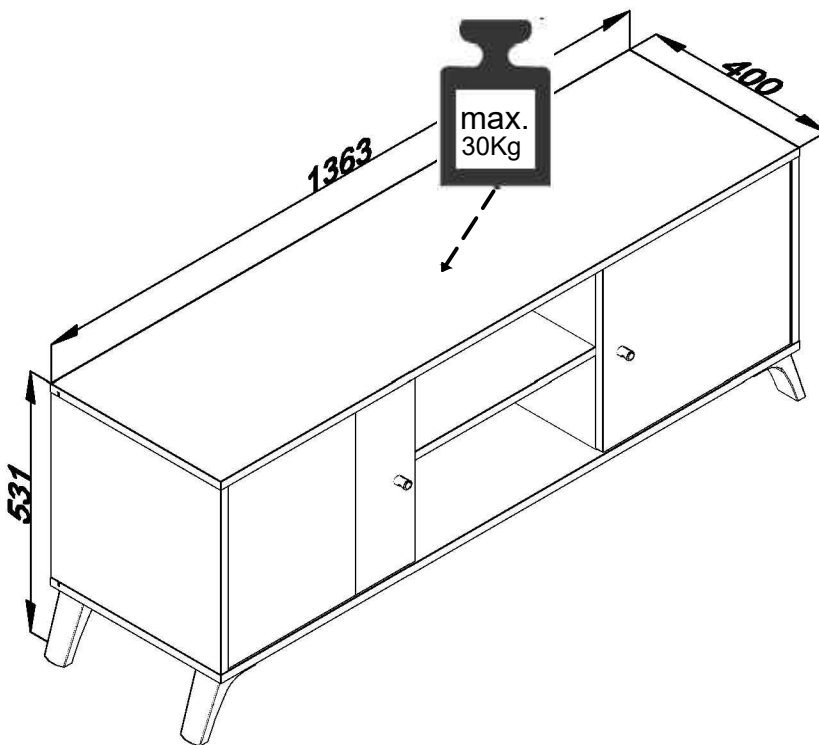

À MONTER SOI-MÊME

AVANT DE COMMENCER, SE
 REPORTER AUX CONSEILS
 DE MONTAGE EN ANNEXE

BEFORE STARTING, REFER
 TO THE ASSEMBLING ADVICE
 IN ANNEX

VOR DER MONTAGE,
 BEILIEGENDE ANWEISUNGEN
 BEFOLGEN.

PRIMA DI COMINCIARE
 LEGGETE LE ISTRUZIONI DI
 MONTAGGIO

ANTES DE COMENÇAR, ADIAR
 SE AOS CONSELHOS DE
 MONTAGEM EM ANEXO

ANTES DE EMPEZAR
 CONSULTE LOS CONSEJOS
 PARA EL MONTAJE

PRIJE POČETKA MONTAŽE
 MOLIMO PAŽLJIVO
 PROČITAJTE UPUTE ZA
 MONTAŽU

BASLAMADAN ÖNCE,
 EKTEKI MONTAJ TALIMATLARINI
 İNCELEYİNİZ

Caja Colis	Tamaño de la caja Dimensions colis	Peso bruto Poids brut	Peso neto Poids net
1/1	1597 x 413 x 94	26,4 Kg	25,8 Kg

"IMPORTANT- À CONSERVER POUR RÉFERENCE ULTÉRIEURE-LIRE ATTENTIVEMENT"

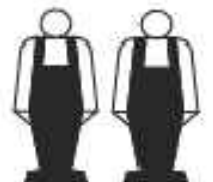
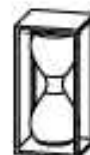

1h:10 min

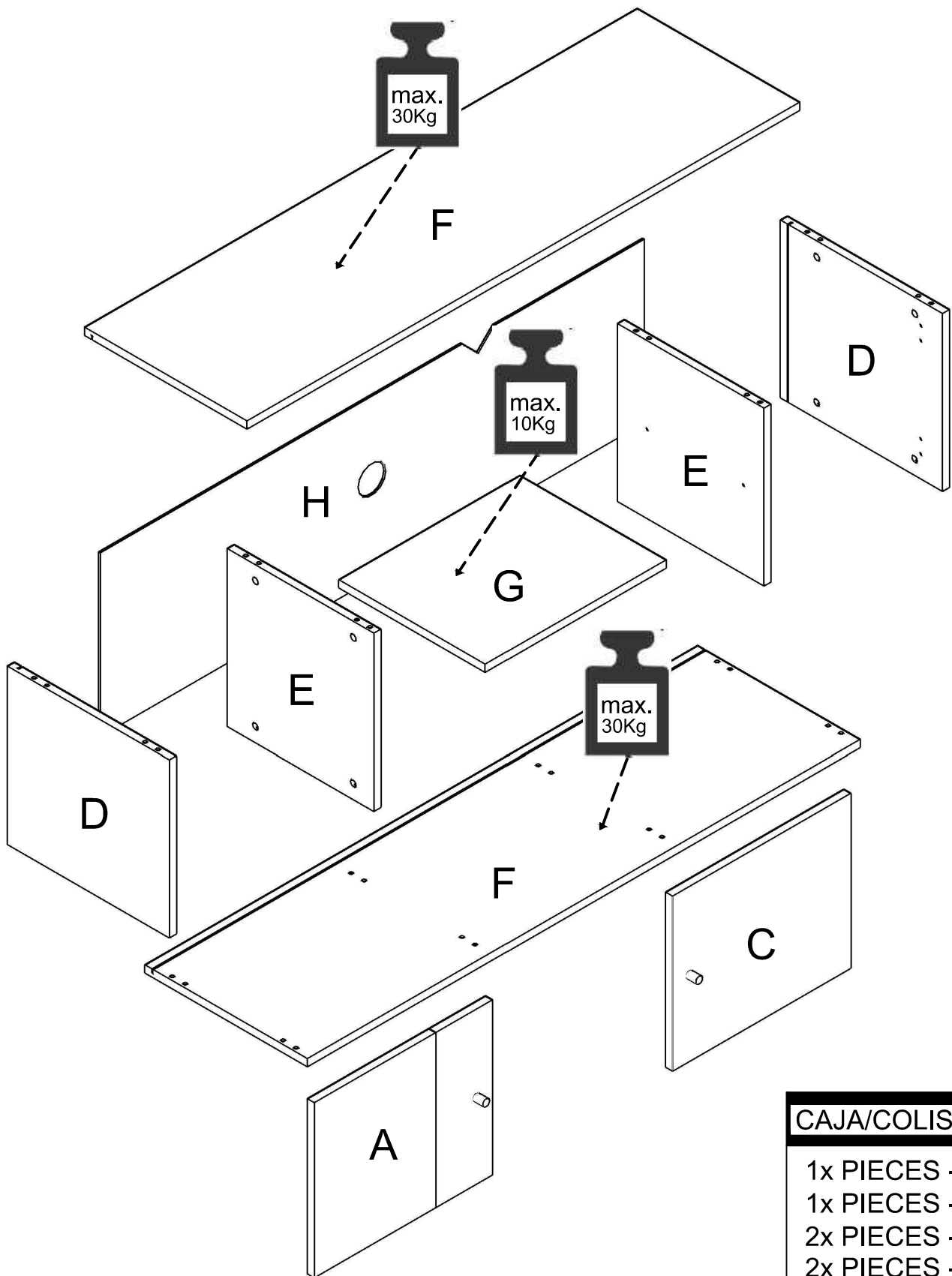

CAJA/COLIS 1/1

- 1x PIECES - A
- 1x PIECES - C
- 2x PIECES - D
- 2x PIECES - E
- 2x PIECES - F
- 1x PIECES - G
- 1x PIECES - H



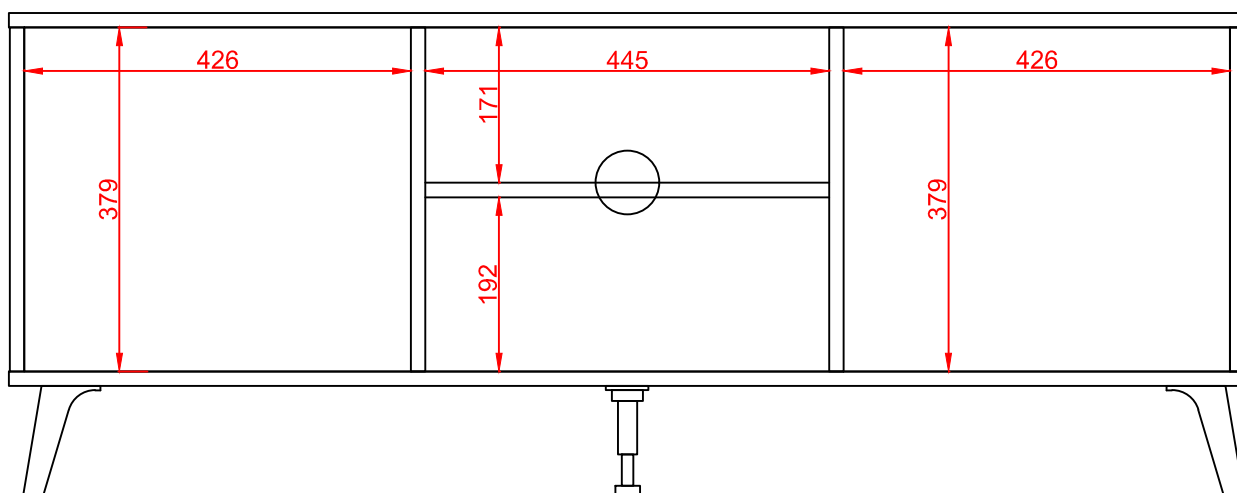



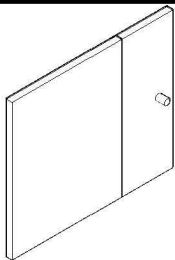
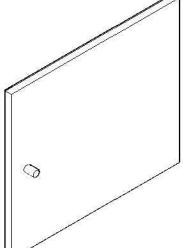
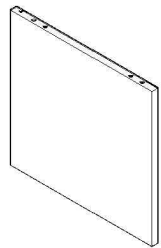
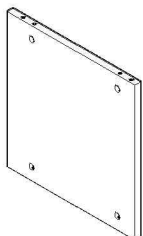
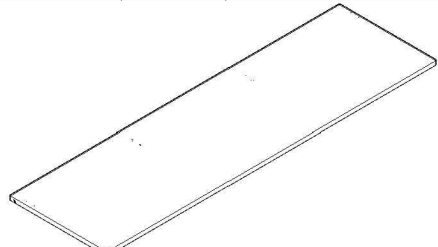
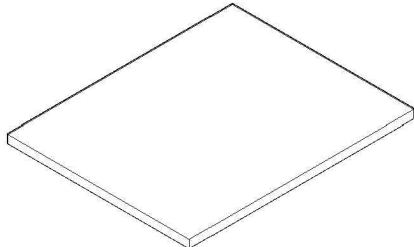
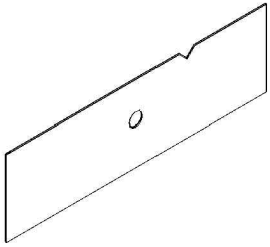



QUINCALLERIE
 NOTICE DE
 MONTAGE



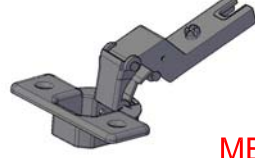
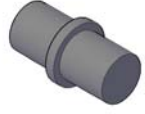

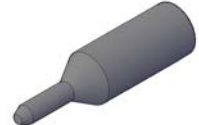
LISTADO DE PIEZAS - COMPOSANTS - PARTS LIST

<p>A</p> 	
<p>5CP1A601 1 Pc 439 x 373 x 16</p>	
<p>C</p> 	<p>D</p> 
<p>1PU9374 1 Pc 439 x 373 x 16</p>	<p>1LA9870 2 Pc 379 x 399 x 16</p>
<p>E</p> 	<p>F</p> 
<p>1LA9871 2 Pc 379 x 361 x 16</p>	<p>1EN9067 2 Pc 1363 x 400 x 16</p>
<p>G</p> 	<p>H</p> 
<p>1SI9744 1 Pc 445 x 360 x 16</p>	<p>MTB2168 1 Pc 1341 x 391 x 3</p>

HERRAJES - QUINCALLERIE - HARDWARE

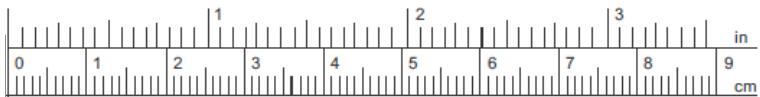
<p>② x16</p>  <p>MTR0420 3,5x15</p>	<p>⑧ x16</p>  <p>MTR0715</p>	<p>⑮ x16</p>  <p>MTR0720</p>
<p>⑮ x16</p>  <p>8x30 MVA0090</p>	<p>⑳ x4</p>  <p>MBB0403</p>	<p>㉔ x4</p>  <p>MBB0273</p>
<p>㉔ x4</p>  <p>MTR0630</p>	<p>㉔ x2</p>  <p>MPM0855</p>	<p>㉔ x1</p>  <p>MCL0090</p>
<p>㉑ x6</p>  <p>MVA0971</p>	<p>㉑ x1</p>  <p>MVA2387</p>	<p>㉑ x4</p>  <p>MVA2252</p>
<p>㉒ x1</p>  <p>MPP0005</p>		



<p>②</p>		<p>3,5x15</p>
<p>⑮</p>		<p>8x30</p>

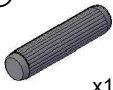

1

"UTILISATION D'UNE COUVERTURE RECOMMANDÉE
AFIN DE NE PAS ABIMER LES PIÈCES LORS DU MONTAGE"

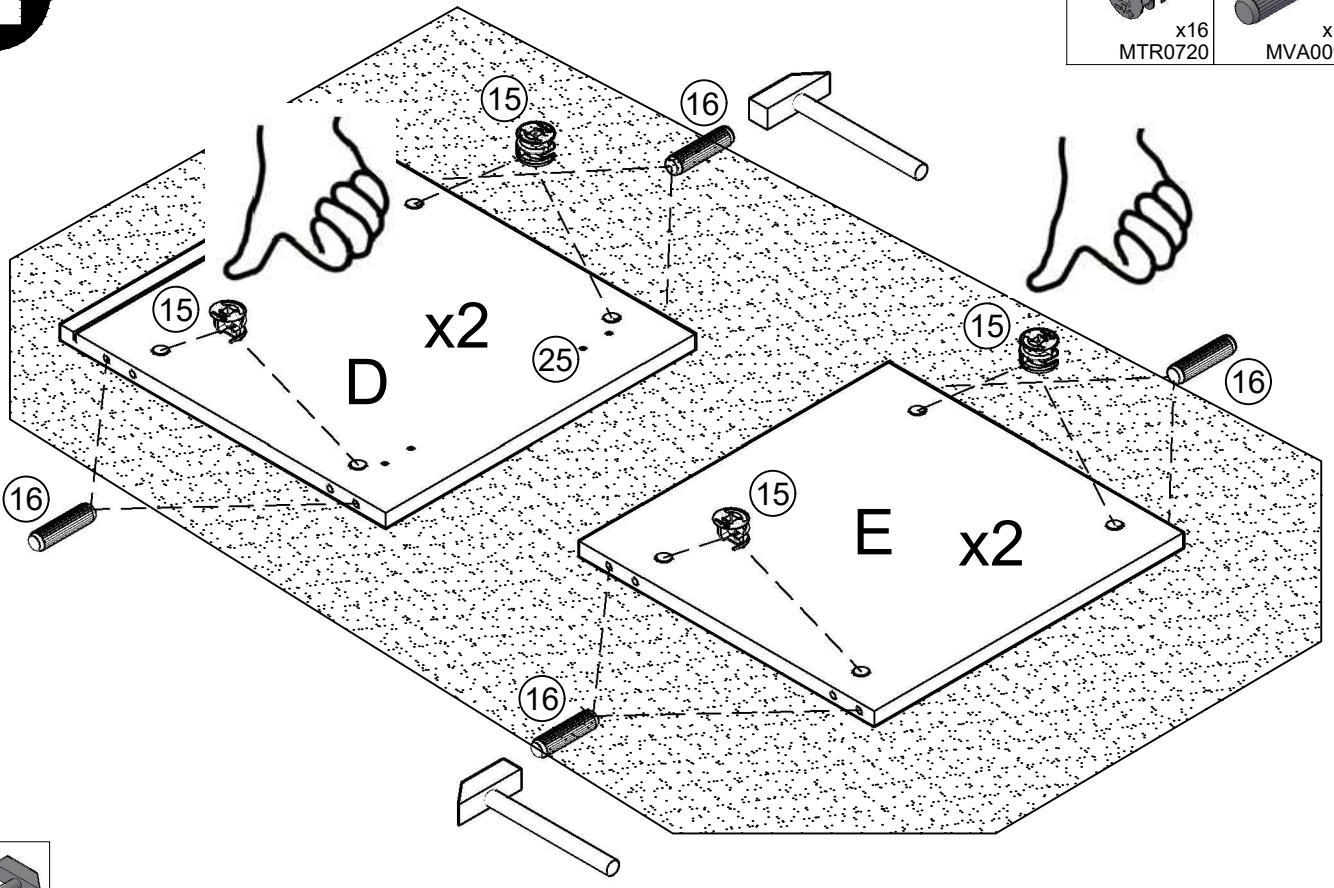
- | | |
|---|---|
| (15) | (16) |
|  |  |
| x16
MTR0720 | x16
MVA0090 |



2

- | | | |
|---|---|---|
| (2) | (8) | (25) |
|  |  |  |
| x8
MTR0420 | x16
MTR0715 | x4
MBB0403 |

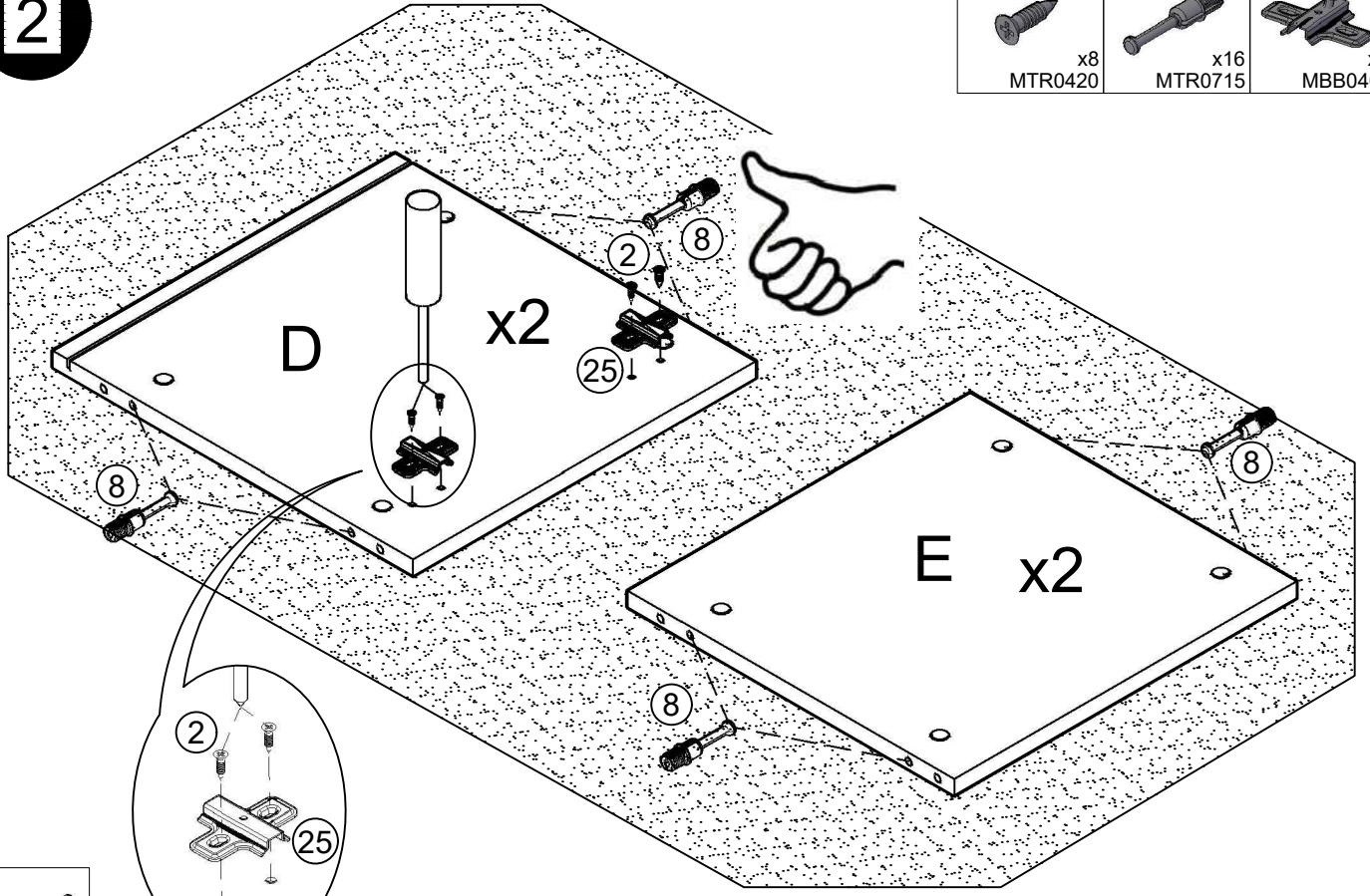

3

②
x8
MTR0420

⑳
x4
MBB0273

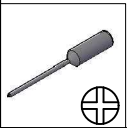
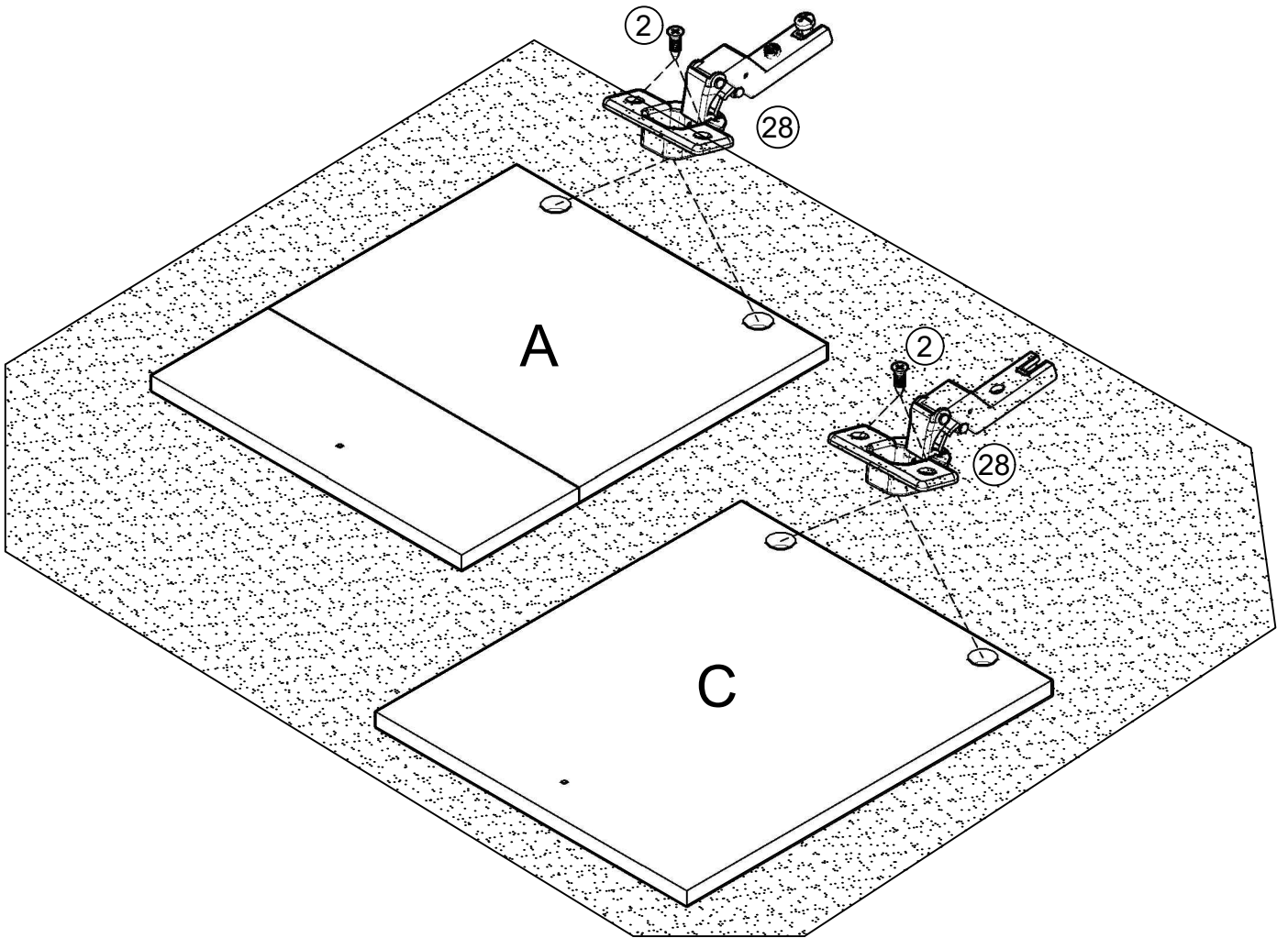

4

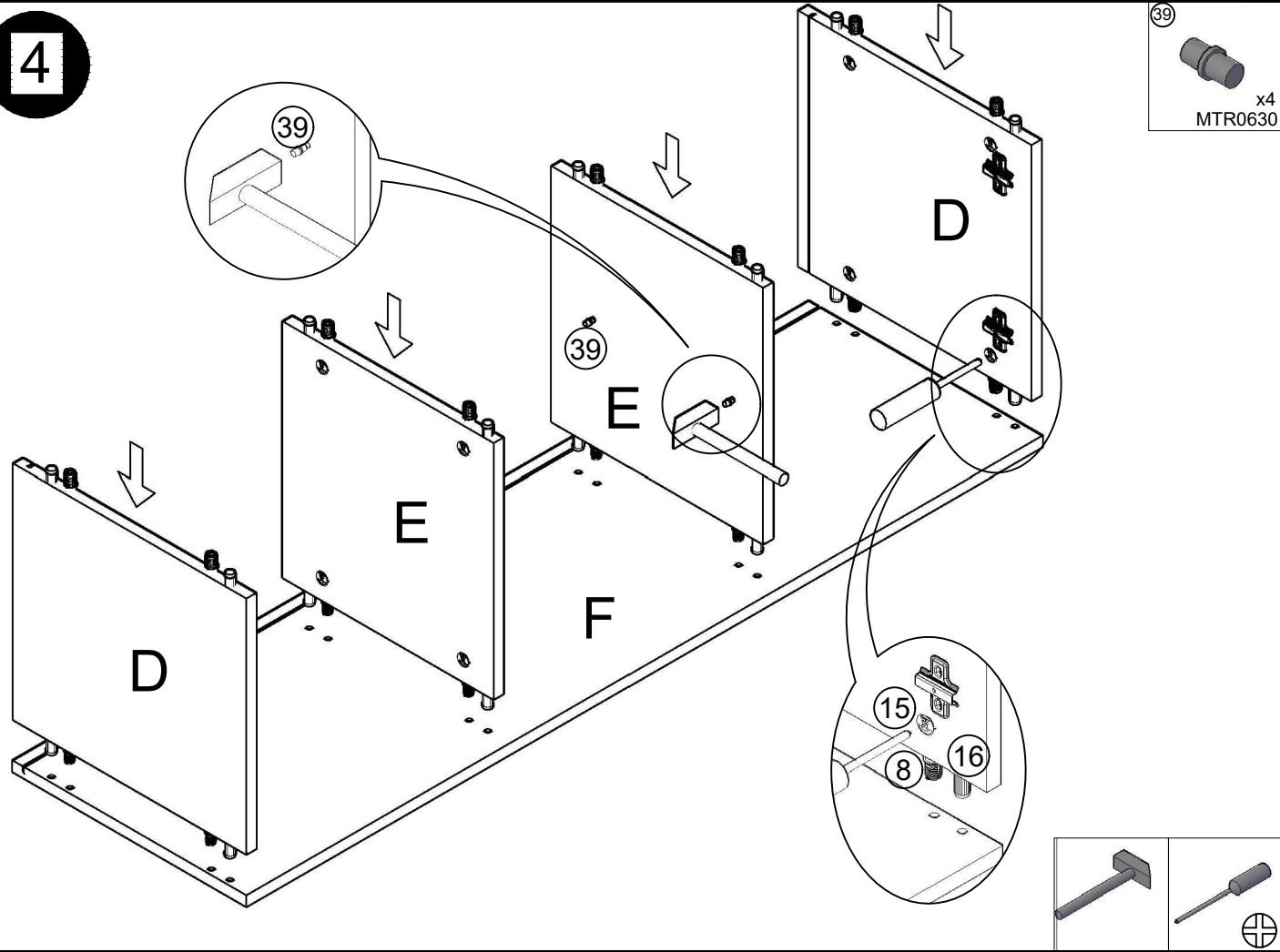

5

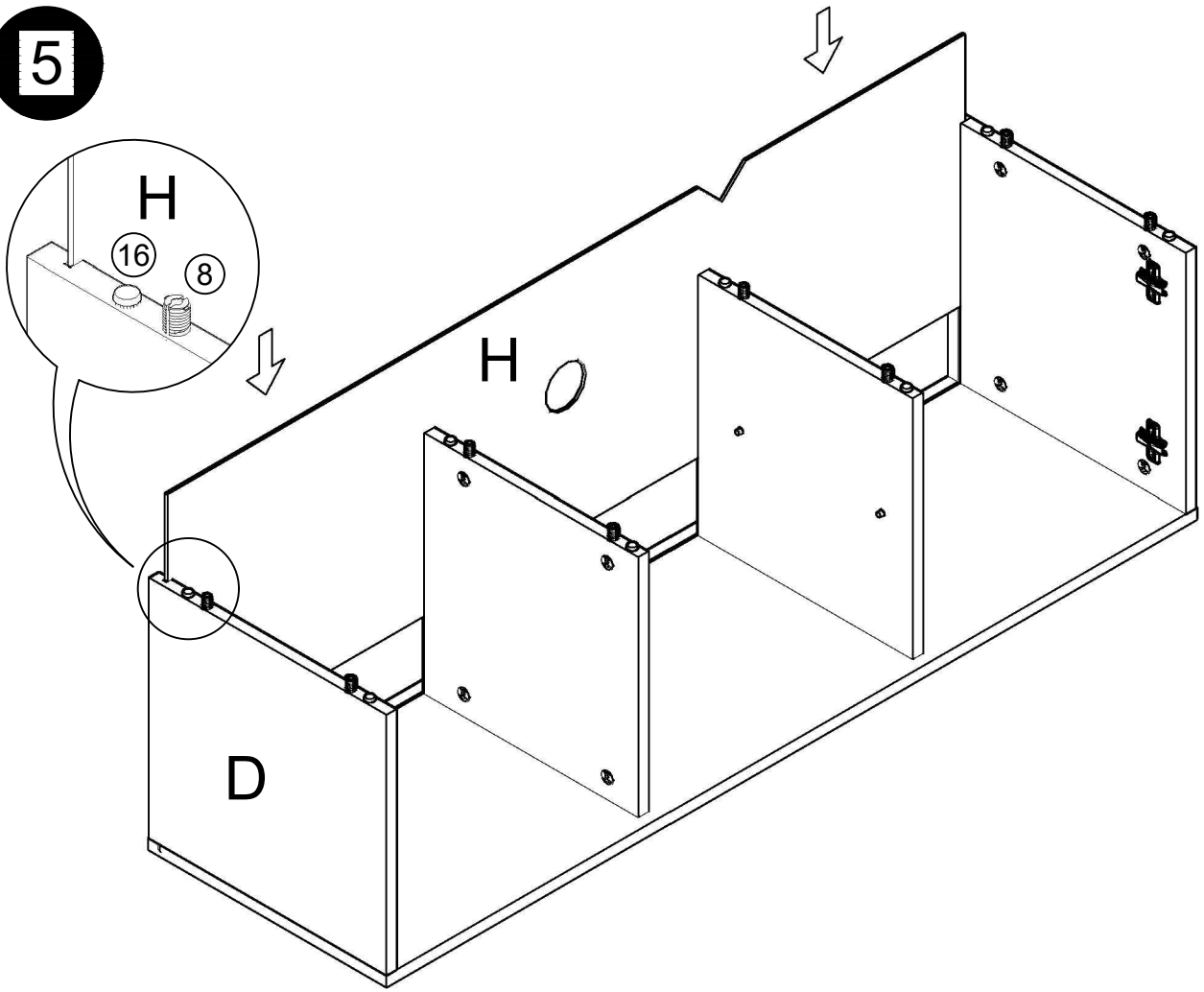

6

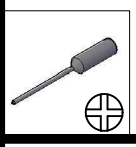
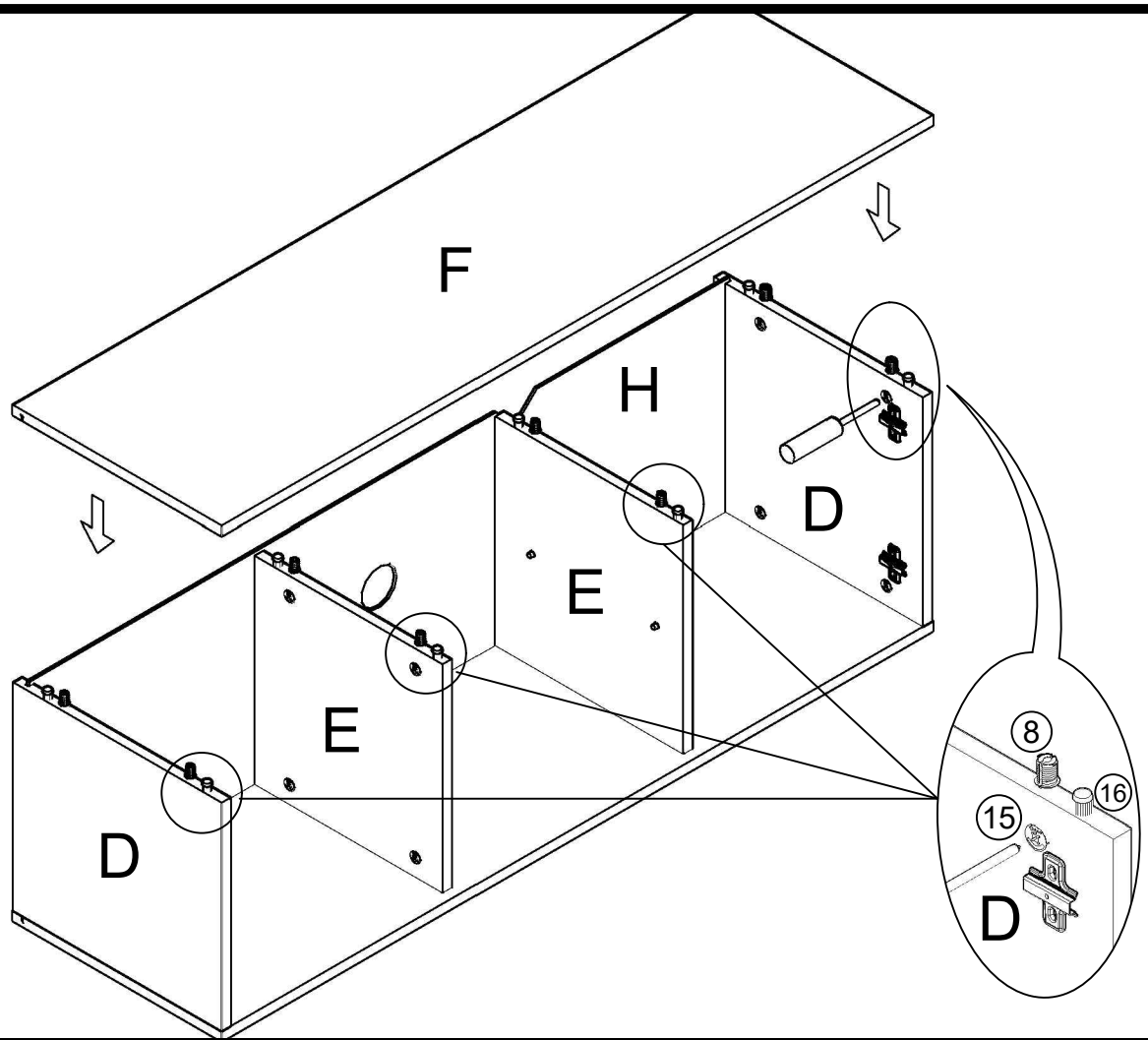

7

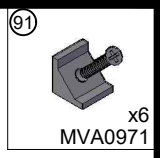
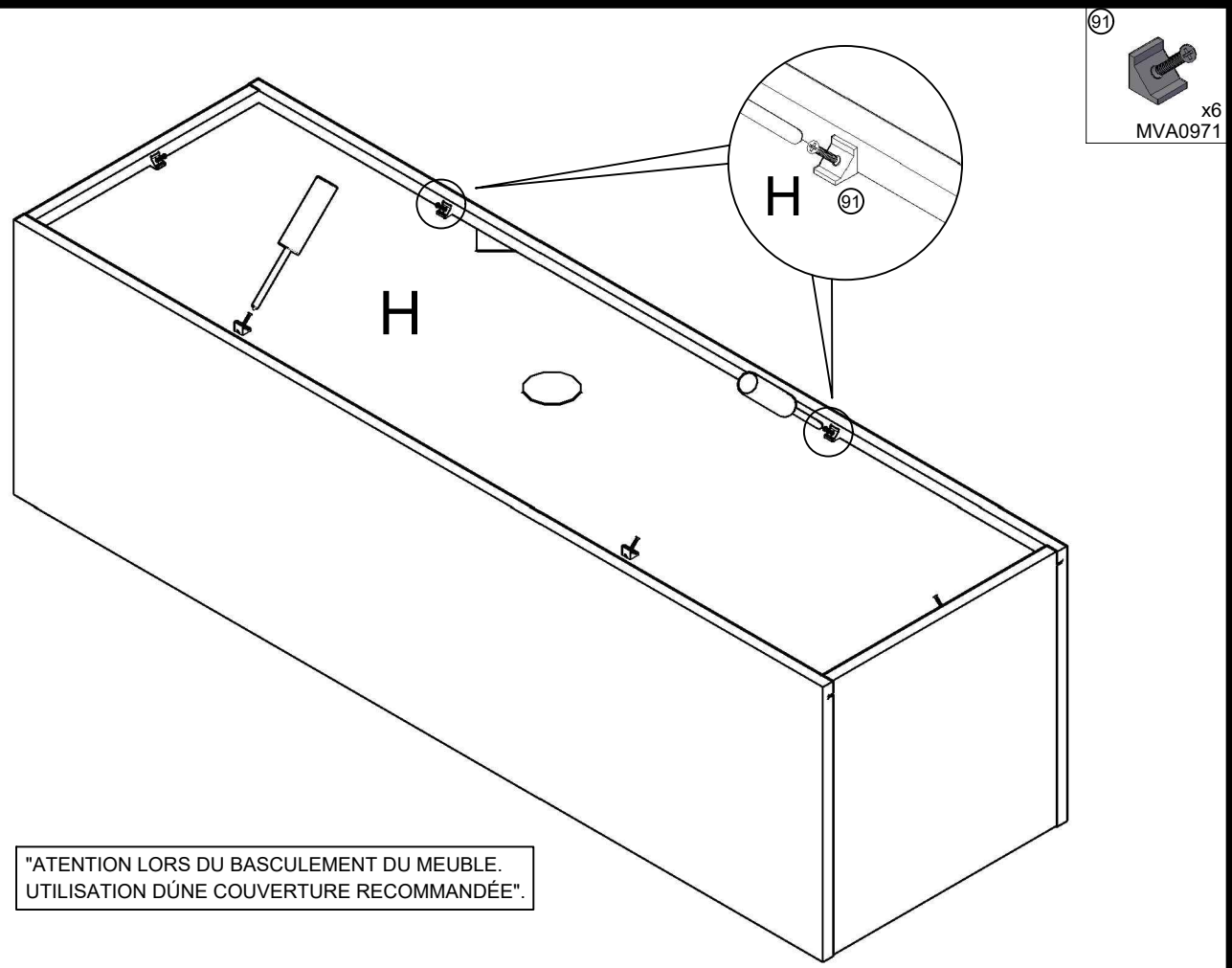

"ATTENTION LORS DU BASCULEMENT DU MEUBLE.
UTILISATION D'UNE COUVERTURE RECOMMANDÉE".

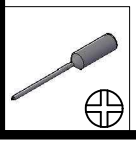

8

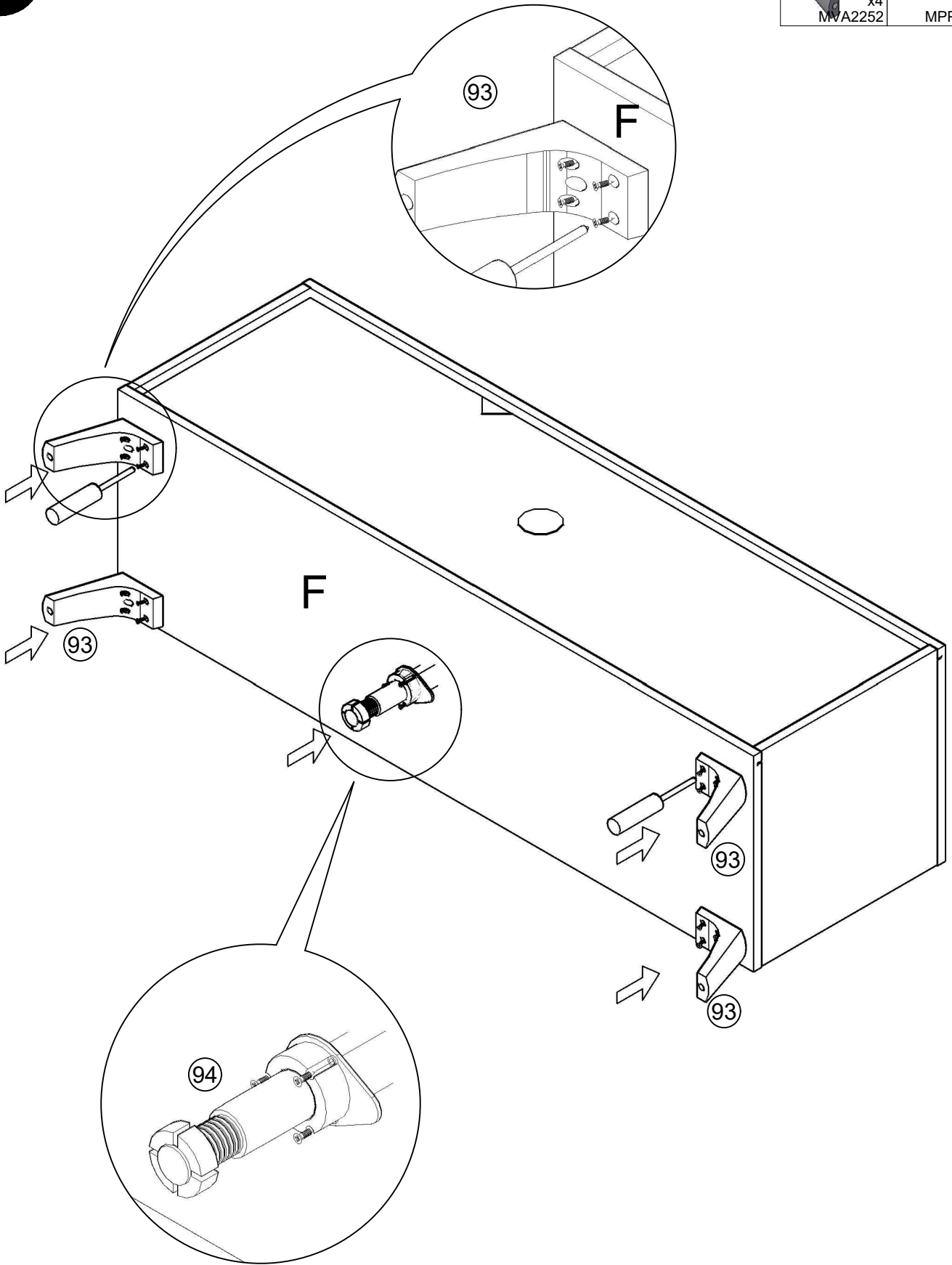
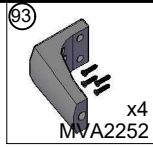



FIXATION MURALE OBLIGATORIE

UTILISEZ DES VIS ET DES CHEVILLES ADAPTÉES A VOS MURS



Il existe une grande diversité de types de murs ou cloisons, c'est la raison pour laquelle nous ne pouvons vous fournir une quincaillerie adaptée à votre mur. Il est nécessaire d'identifier le type de paroi à laquelle vous allez fixer ce produit afin de vous procurer les fixations appropriées. En cas de besoin, adressez vous à un magasin spécialisé pour conseil



OBLIGATORIO FIJAR A LA PARED

UTILICE LOS TORNILLOS Y TACOS ADECUADOS PARA SU MURO



Existe una gran diversidad de muros y paredes, por esta razón no podemos proporcionarle el herraje adecuado para su pared. Primero, es necesario identificar el tipo de pared para luego utilizar el herraje adecuado. En caso de duda, diríjase a una tienda especializada para más información.



OBLIGATORY FIX ON THE WALL

USE SCREWS AND PLUGS SUITABLES FOR YOUR WALL



Due to the wide diversity of wall or partition types, we cannot provide you with suitable attachment fixtures. To determine which attachment fixtures to use, you will need to identify the type of wall to which you will be fixing this product. If you have whatever doubt, please, go to one specialised shop for further information.

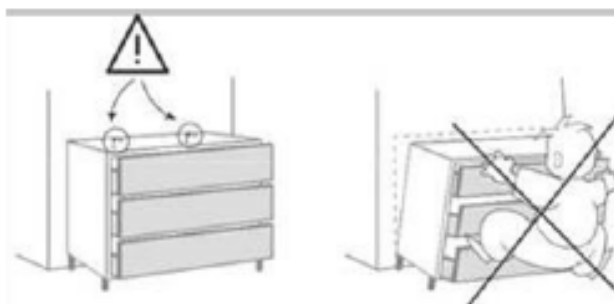

French

IMPORTANT: Pour éviter le basculement accidentel du meuble, la fixation du meuble au mur est obligatoire.

La visserie nécessaire pour la jonction mur/meuble, dépendante de la nature du mur, n'est pas fournie. En cas de doute, consulter un spécialiste

English

IMPORTANT: To avoid the accidental tip-over of the furniture, the fixing of the furniture on the wall is mandatory.

The needed hardware for the junction wall/furniture, depending of the nature of the wall, is not provided. If any doubt, consult a specialist.

Spanish







IMPORTANTE: Para evitar el vuelco accidental de los muebles, es obligatorio fijarlos en la pared.

El tipo de tornillos necesarios para fijar el mueble a la pared, dependen del material de la pared, no se suministran. En caso de duda, consulte a un especialista

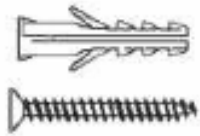
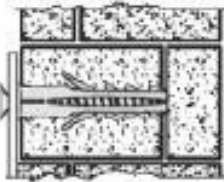
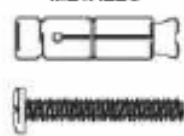
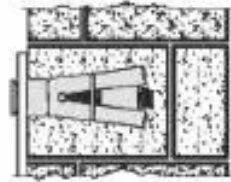

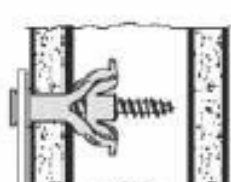
Esiste una gran varietà di tipi di muri o paratie e noi siamo in grado di fornirvi il tipo esatto di fissaggio per ognuno di essi. E' necessario identificare il tipo di parete alla quale intendete fissare questo prodotto in modo da fornirvi i fissaggi più idonei, Ecco qualche esempio di fissaggi consigliati per :

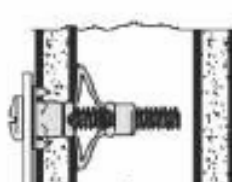

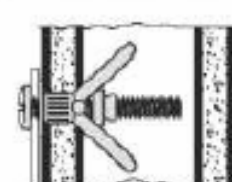
I MURI PIENI		PARATIE CAVE		
TASSELLO NYLON "FISCHER"  	TASSELLO DI ANCORAGGIO IN METALLO  	TASSELLO DI ANCORAGGIO AD ALETTE IN NYLON  	TASSELLO METALLICO AD ESPANSIONE  	TASSELLO "MOLLY"  

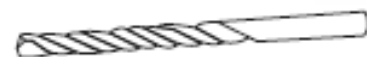







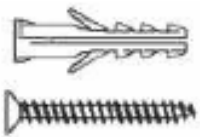
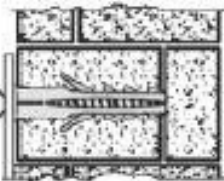

Utilizzare una punta di trapano adatta agli utensili utilizzati e al tipo di muro.

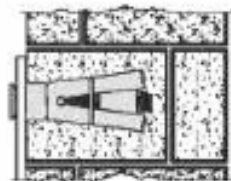

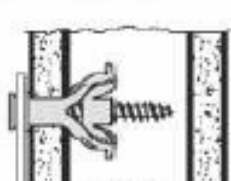
Il existe une grande diversité de types de murs ou cloisons, c'est la raison pour laquelle nous ne pouvons vous fournir le type exact de fixation. Il est nécessaire d'identifier le type de paroi à laquelle vous allez fixer ce produit afin de vous procurer les fixations appropriées. Voici quelques exemples de fixations conseillées pour :

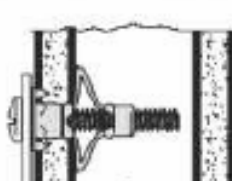

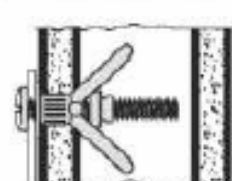

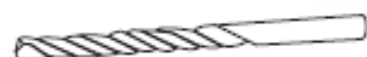



LES MURS PLEIS		LES CLOISONS CREUSES		
Cheville nylon "FISCHER"  	Cheville d'ancrage métal  	Cheville d'ancrage A ailettes en nylon  	Cheville métallique A expansion  	Cheville "MOLLY"  

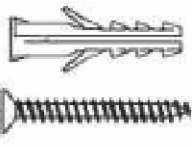
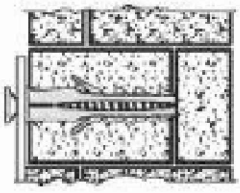

Utiliser une talle de forêt adaptée à la quincaillerie utilisée et au type de mur.

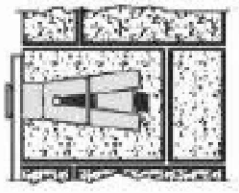

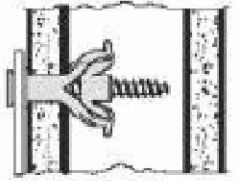
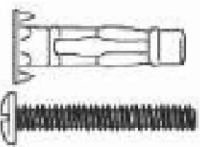
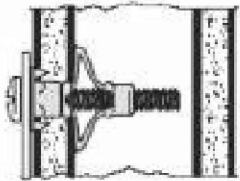
Due to the wide diversity of wall or partition types, we cannot provide you with suitable attachment fixtures. To determine which attachment fixtures to use, you will need to identify the type of wall to which you will be fixing this product. Here are some examples of attachment fixtures recommended for:

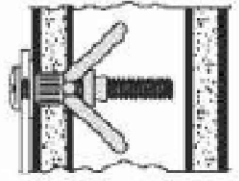
BLIND WALLS		STUDDED WALLS		
<p>"FISCHER" Nylon plug</p>  	<p>Metal Wall plug</p>  	<p>Nylon winged Wall plug</p>  	<p>Metal expansion plug</p>  	<p>"MOLLY" plug</p>  



Use a drill bit that is compatible in size with the hardware used and the type of wall.

9

! FIXATION MURALE OBLIGATORIE !
! OBLIGATORIO FIJAR A LA PARED !
! OBLIGATORY FIX ON THE WALL !

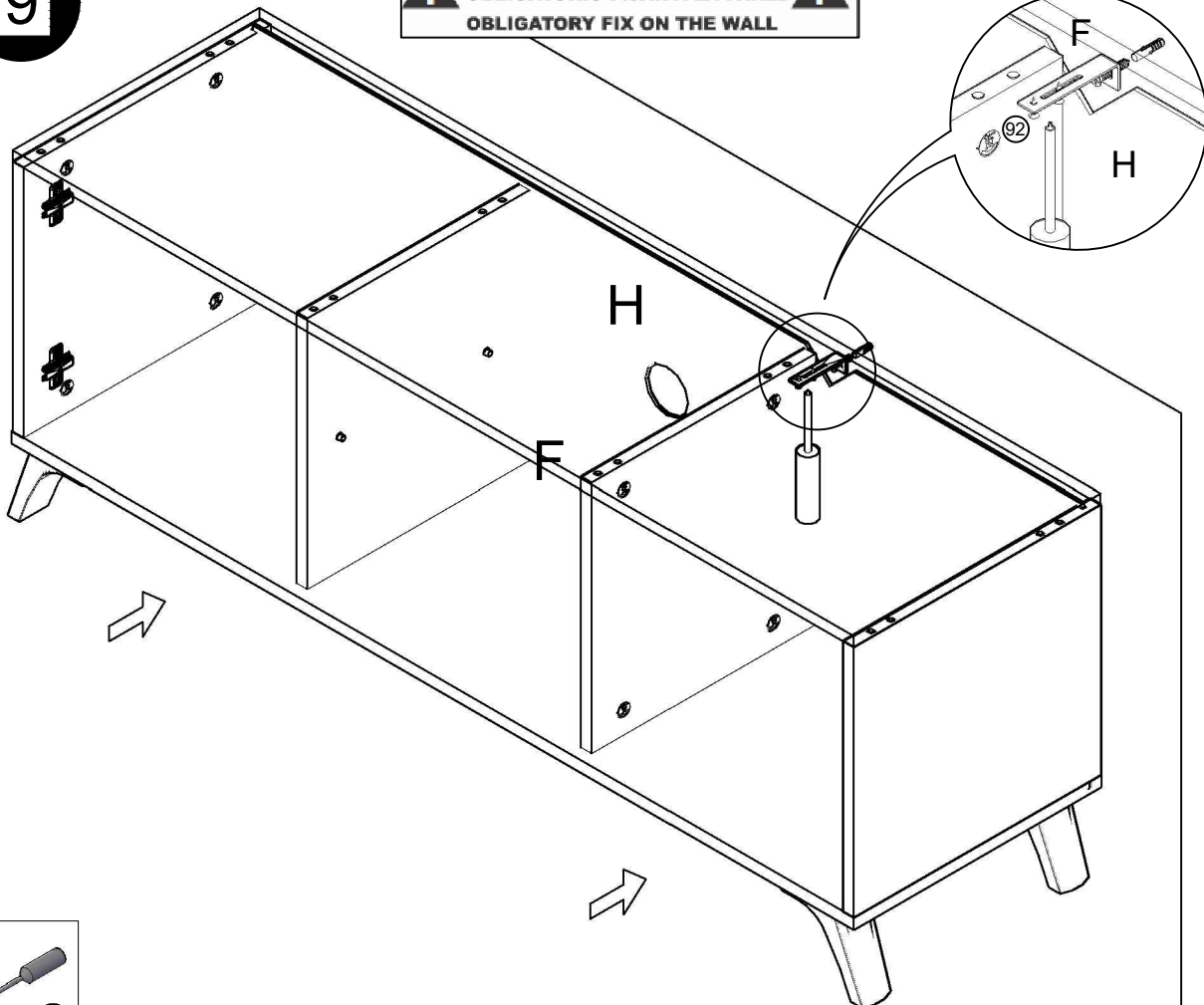
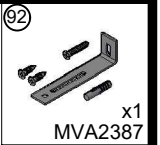

10

40

x2
MPM0855

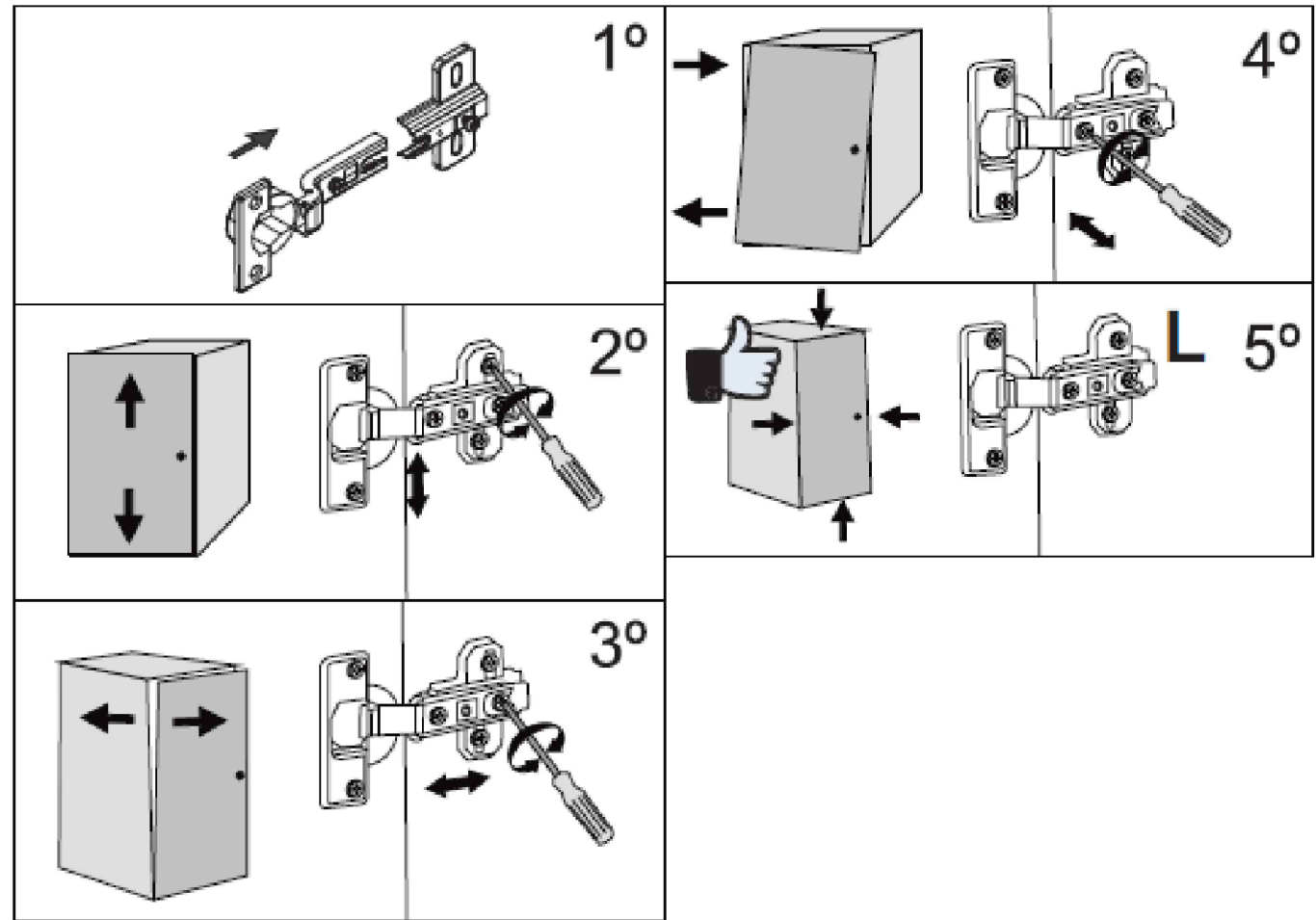
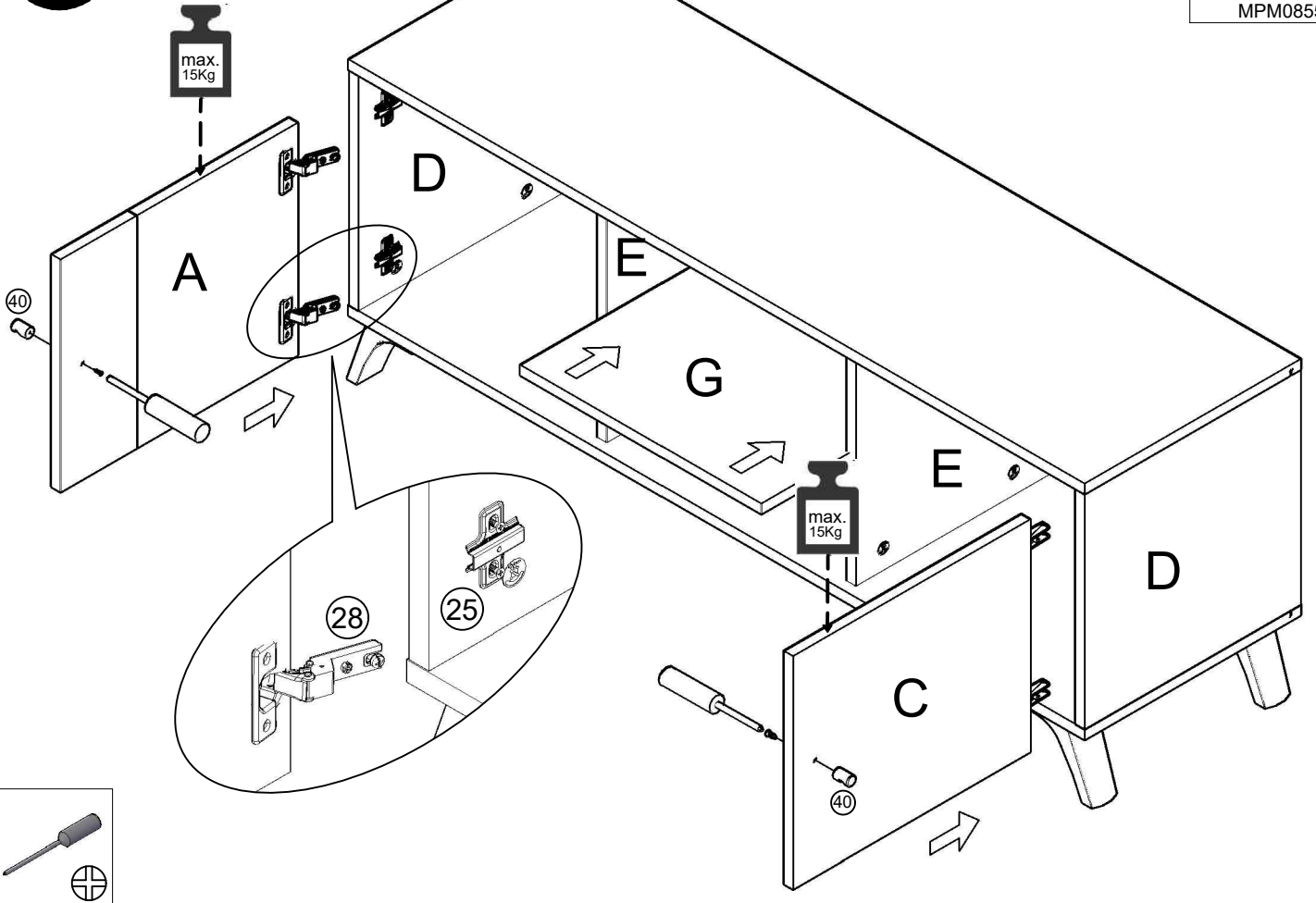

FRENCH: "Les meubles contenant des panneaux à base de bois (panneaux de particules, panneaux de fibres, contreplaqué...) peuvent émettre des substances polluantes dans l'air intérieur. Il est ainsi recommandé, après l'installation du meuble dans son logement, d'aérer fréquemment la pièce concernée pendant au moins quatre semaines afin de réduire son exposition aux polluants émis par le meuble."

SPANISH: Los muebles que contienen paneles a base de madera (Aglomerado, cartón, contrachapado ...) pueden emitir sustancias contaminantes en el aire. Por lo tanto, se recomienda airear frecuentemente los muebles al menos durante cuatro semanas después de su instalación para reducir su exposición a los contaminantes emitidos por los muebles.

ENGLISH: Furniture containing wood-based panels (Particle board, fibreboard, plywood ...) could emit pollutants on the air. Therefore, it is advisable to ventilate the furniture at least during four weeks after its assembly in order to reduce the exposure to the pollutants released by the furniture.

FRANCAIS - SUISSE

CONSEILS DE MONTAGE :

- 1 > BIEN ETUDIER LA NOTICE DE MONTAGE.
- 2 > REPEREZ LES PIÈCES CONSTITUANT VOTRE MEUBLE.
- 3 > REGROUPEZ ET CONTROLEZ LA QUINCAILLERIE.
- 4 > MUNISSEZ-VOUS DE L'OUTILLAGE NECESSAIRE.
- 5 > AMENAGEZ-VOUS UNE ZONE DE MONTAGE.
- 6 > PROCEDEZ AU MONTAGE.



**NE JAMAIS FORCER LES ASSEMBLAGES.
RESSERREZ LES VIS APRES QUELQUES TEMPS D'USAGE.
GARDER VOTRE NOTICE DE MONTAGE, SI UNE PIÈCE
VENAIT A MANQUER, ELLE SERAIT LE PLUS CLAIR
MOYEN DE COMMUNIQUER AVEC VOTRE MAGASIN.**

CONSEILS D'ENTRETIEN :

- 1 > DÉPOUSSIÉREZ SOIGNEUSEMENT.
- 2 > UTILISEZ UN CHIFFON SEC.



**- NE JAMAIS UTILISER
DE PRODUITS ABRASIFS:
POUDRE, LAINE D'ACIER, SOLVANTS.
- NE PAS MOUILLER**

	PAPIER DECOR	SURFACES STRATIFIÉES	SURFACES LAQUÉES	BOIS VERNIS	TEXTILE CUIR
EAU SAVONNEUSE (SAVON NEUTRE)	○	○	○	○	○
EAU ADDITIO NÉE		○	○		
ENTRETIEN SPÉCIFIQUE FABRICANT					○

DEUTSCH - SCHWEIZ

MONTAGE ANLEITUNG:

- 1 > DIE MONTAGEANLEITUNG SORGFÄLTIG DURCHLESEN.
- 2 > DIE EINZELTEILE DES MÖBELSTÜCKS ERMITTELN.
- 3 > DIE BESCHLÄGE ZUSAMMENLEGEN UND PRÜFEN.
- 4 > DAS NOTWENDIGE WERKZEUG ZURECHTLEGEN.
- 5 > EINEN MONTAGEBEREICH FREIMACHEN.
- 6 > DAS MÖBELSTÜCK ZUSAMMENBAUEN.



**NIEMALS DIE VERBINDUNGEN ZU STARK ANZIEHEN.
DIE SCHRAUBEN NACH EINIGER ZEIT DES GEBRAUCHS
ERNEUT FESTZIEHEN. DIE MONTAGEANLEITUNG
GUT AUFBEWAHREN: SOLLTE EIN TEIL FEHLEN, IST SIE DAS
BESTE VERSTÄNDIGUNGSMITTEL MIT IHREM GESCHÄFT.**

PFLEGEHINWEISE :

- 1 > SORGFÄLTIG ENTSTAUBEN.
- 2 > VERWENDEN SIE EIN TROCKENES TUCH.



**- BENUTZEN SIE KEINE
SCHEUERMITTEL WIE PULVER,
STAHLWOLLE, LÖSUNGSMITTEL.
- KEIN WASSER VERWENDEN.**

	DEKORPAPIER	OBERFLÄCHE LAMINAT	OBERFLÄCHE LACK	LACKIERTEM HOLZ	TEXUL LEDER
SEIFENLAUGE (NEUTRALSEIFE)	○	○	○	○	○
WASSER MIT HAUSHALTSRFINIGER		○	○		
PRODUZENT SPEZIFISCHER UNTERHALT					○

ITALIANO - SVIZZERA

CONSIGLI DI MONTAGGIO

- 1 > STUDIARE BENE LE ISTRUZIONI DI MONTAGGIO.
- 2 > PRENDERE CONOSCENZA DEI PEZZI CHE COSTITUISCONO IL MOBILE.
- 3 > RAGGRUPPARE E CONTROLLARE LA FERRAMENTA.
- 4 > MUNIRSI DEGLI UTENSILI NECESSARI.
- 5 > PREPARARE UNA ZONA DI MONTAGGIO.
- 6 > PROCEDERE AL MONTAGGIO.



**NON FORZARE MAI GLI ASSEMBLAGGI
RISTRINGERE LE VITI DOPO UN PERIODO D'USO
CONSERVARE QUESTE ISTRUZIONI DI MONTAGGIO,
SE UN PEZZO VENISSE A MANCARE SAREBBE IL MIGLIORE
MEZZO DI COMUNICAZIONE CON IL RIVENDITORE**

CONSIGLI PER LA MANUTENZIONE :

- 1 > SPOLVERATE ACCURATAMENLE.
- 2 > USARE UN PANNINO ASCIUTTO.



**- NON UTILIZZARE MAI PRODOTTI
ABRASIVI: POLVERE,
LANA DI ACCIAIO, SOLVENTI.
- NON BAGNARE.**

	CARTA	SUPERFICIE STRATIFICATE	SUPERFICIE LACCATE	LACCATE EGNO VERNICIATO	TESSILE CUOIO
ACQUA CON SAPONE (SAPONE NEUTRO)	○	○	○	○	○
ACQUA CON DETERSIVO SAN MARC		○	○		
MANUTENZIONE SPECIFICA PRODUTTORE					○

PORTUGUÊS

CONSELHOS DE MONTAGEM:

- 1 > ESTUDE BEM AS INSTRUÇÕES DE MONTAGEM.
- 2 > REUNA AS PEÇAS QUE CONSTITUEM O SEU MÓVEL.
- 3 > REAGRUPE AS FERRAGENS.
- 4 > EQUIPE-SE COM AS FERRAMENTAS NECESSÁRIAS.
- 5 > PREPARE UMA ÁREA PARA A MONTAGEM.
- 6 > INICIE A MONTAGEM.



**NUNCA FORÇAR OS ENCAIXES.
REAPERTAR OS PARAFUSOS APÓS UM TEMPO DE UTILIZAÇÃO.
GUARDAR AS INSTRUÇÕES DE MONTAGEM.
CASO FALTE ALGUMA PEÇA, O MAIS ACONSELHÁVEL
É CONTATAR O REVENDEDOR.**

CONSELHOS PARA A MANUTENÇÃO :

- 1 > ELIMINAR BEM O PÓ.
- 2 > USAR PANO SECO.



**- NUNCA UTILIZAR PRODUTOS
ABRASIVOS: SAPONÁCEOS,
LÃ DE AÇO, SOLVENTES.
- NÃO MOLHAR .**

	ACABAMENTO IMITAÇÃO	SUPERFÍCIES ESTRATIFICADAS	SUPERFÍCIES LACADAS	MADEIRA ENVERNIZADA	TEXTEIS PELES
ÁGUA COM SABÃO (SABÃO NEUTRO)	○	○	○	○	○
ÁGUA COM DETERGENTE		○	○		
INSTRUÇÕES ESPECÍFICAS DO FABRICANTE					○

ESPAÑOL

CONSEJOS PARA EL MONTAJE:

- 1 > ESTUDIE ATENTAMENTE EL MANUAL DE MONTAJE.
- 2 > LOCALICE LAS PIEZAS QUE CONSTITUYEN SU MUEBLE.
- 3 > REUNA Y CONTROLE LOS TORNILLOS.
- 4 > EQUIPE-SE DE LAS HERRAMIENTAS NECESARIAS.
- 5 > PREPARE UNA ZONA DE MONTAJE.
- 6 > REALICE EL MONTAJE.



**NO FUERCE NUNCA EN LAS UNIONES. APRIETE LOS
TORNILLOS DESPUES DE CIERTO TIEMPO DE UTILIZACION
CONSERVE SU MANUAL DE MONTAJE,
SI FALTARA UNA PIEZA, SERIA LA MANERA
MAS FACIL DE COMUNICAR CON LA TIENDA.**

CONSEJOS PARA EL MANTENIMIENTO:

- 1 > DESPOLVOREAR CULDADOSAMENTE.
- 2 > UTILICE UN PAÑO SECO.



**- NO USE NUNCA PRODUCTOS
ABRASIVOS TALES COMO:
POLVO DE LIMPIAR,
LANA DE ACERO, SOLVENTES.
- NO MOJAR.**

	PAPEL DE DECORACION	SUPERFICIE ESTRATIFICADAS	SUPERFICIE MAQUEADAS	MADERA BARNIZADA	TEXULL CUERO
AGUA Y JABON (JABON NEUTRO)	○	○	○	○	○
AGUA COM DETERGENTE		○	○		
MANTENIMIENTO ESPECIFICO DEL FABRICANTE					○

HRVATSKA

UPUTE ZA MONTAŽU:

- 1 > PAŽLJIVO PROČITAJTE UPTE ZA MONTAŽU.
- 2 > PRIPREMITE SVE DIJELOVE NAMJEŠTAJA.
- 3 > PRIKUPITE I PROVJERITE OKOVE ZA MONTAŽU.
- 4 > PRIPREMITE POTREBAN ALAT.
- 5 > PRIPREMITE PROSTOR ZA MONTAŽU.
- 6 > POČNITE MONTIRATI.



**NEMOJTE UPOTREBLJAVATI SILU PRILIKOM SKLAPANJA
NAKON NEKOG VREMENA PONOVRNO PRITEGNITE VIJKE
ČUVAJTE UPUTE ZA MONTAŽU
U SLUČAJU NEDOSTATKA NEKOG DIJELA NAJBOLJE ĆE BITI DA
DA KONTAKIRATE PRODAJNO MJESTO.**

UPUTE ZA ODRŽAVANJE :

- 1 > PAŽLJIVO OBRISATI PRAŠINU.
- 2 > KORISTITE SUHU KRPU.



**- ZABRANJENA JE UPOTREBA
KEMIKALIJA ILI BILO KAKVIH
POMOĆNIH SREDSTAVA ZA RIBANJE
JAKIH SREDSTAV ZA ČIŠĆENJE ILI
ČELIČNE VUNE
-NE MOKRA.**

	PAPIR	LAMINAT	LAK	DRVO	TEKSTIL/ KOŽA
OTPINA SAPUNA	○	○	○	○	○
OTPINA DETERDŽENTA		○	○		
NAMJENSKA SREDSTVA					○

TÜRÇE

MONTAJ TALIMATLARI:

- 1 > MONTAJ TANITIM YAZISINI DIKKATLICE OKUYUNUZ .
- 2 > MOBILİYANIZI OLUŞTURAN PARÇALARI İŞARETLEYİNİZ.
- 3 > HIRDAVATLA İLGİLİ PARÇALARI BİR ARAYA TOPLAYIP; KONTROL EDİNİZ.
- 4 > GEREKEN ARAÇ VE GEREÇİ TEDARİK EDİNİZ.
- 5 > (KENDİNİZE) BİR MONTAJ ALANI EDİNİNİZ.
- 6 > MONTE ETMEYE BAŞLAYINIZ.



**MONTAJLARI ZORLAMAYINIZ.
BİRKAÇ KULLANIMDAN SONRA VIDALARI SIKIŞTIRINIZ.
BİR PARÇANIN KAYBOLMASI DURUMUNDA MAGAZANIZLADAKİ
KOLAY İLETİŞİME GEÇEBİLMENİZ İÇİN MONTAJ KULLANIM
TALIMATINIZI SAKLAYINIZ.**

BAKIM TALIMATLARI:

- 1 > TOZUNU DIKKATLICE ALINIZ.
- 2 > YUMUŞAK BİR BEZİ TEMİZ SU VE AZ MİKTARDA SABUNLA(DETERJAN) NEMLENDİRİNİZ.



**ASLA AŞINDIRICI ÜRÜNLER
KULLANMAYINIZ : ÇELİK YÜNÜ,
SOLVENT...
BOL SUYLA YIKAMAYINIZ.**

	SÜS KAGIDI	KATMAN YÜZEY	LAKE YÜZEY	CILALI TAHTA	TEKSTİL DERİ
SABUNLU SU (NOTR SABUN)	<input type="radio"/>	<input type="radio"/>	<input type="radio"/>	<input type="radio"/>	<input type="radio"/>
DETERJAN KATILMIŞ SU		<input type="radio"/>	<input type="radio"/>		
ÜRETİCİYE ÖZGÜ BAKIM					<input type="radio"/>

ENGLISH

ASSEMBLY ADVICE :

- 1 > CAREFULLY READ THE ASSEMBLY INSTRUCTION.
- 2 > IDENTIFY THE COMPONENTS OF THE FURNITURE.
- 3 > GROUP AND CHECK THE HARDWARE.
- 4 > USE THE REQUIRED TOOLS.
- 5 > CREATE AN ASSEMBLY ZONE.
- 6 > MAKE THE ASSEMBLY.



**NEVER FORCE THE CONNECTIONS.
RE-TIGHTEN THE SCREWS AFTER FEW DAYS.
PLEASE RETAIN THE AI LEAFLET FOR FUTURE REFERENCE,
THE AI CONTAINS INFORMATION WHEN CLAIMING
FOR MISSING PARTS.**

CLEANING ADVICE:

- 1 > CAREFULLY REMOVE THE DUST.
- 2 > USE A SOFT, CLEAN DAMP CLOTH WITH SOAPY WATER.



**NEVER USE ABRASIVE PRODUCTS
OR SOLVENTS.
DO NOT APPLY EXCESSIVE PRESSURE
WHEN USING THE DAMP CLOTH.**

	PAPER DECOR	LAMINATED SURFACES	LACQUERED SURFACE	VARNISHED WOOD	LEATHER TEXTILE
SOAPY WATER (NEUTRAL SOAP)	<input type="radio"/>	<input type="radio"/>	<input type="radio"/>	<input type="radio"/>	<input type="radio"/>
WATER WITH DETERGENT		<input type="radio"/>	<input type="radio"/>		
SPECIFIC SUPPLIER CLEANING					<input type="radio"/>

**PENSEZ
AU TRI!**



ENSEMBLE
REDUISONS L'IMPACT
ENVIRONNEMENTAL
DES EMBALLAGES

ÉLÉMENTS BOIS
PLASTIQUE



A JETER

ÉLÉMENTS
METAL CARTON
PAPIER



A RECYCLER



CONSIGNE POUVANT VARIER LOCALEMENT> WWW.CONSIGNESDETRI_FR