

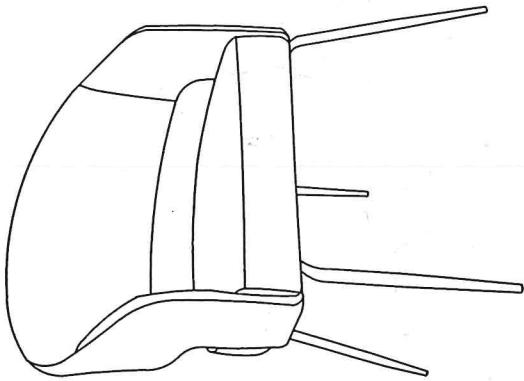







ASSEMBLY INSTRUCTIONS

DINING CHAIR MODEL#: UDC21136



 X1
 0:10

 X1	 X1	 X1
A  M6*40 X6	B  X6	C  X1

1

