

Reference no:

Designed by

Leonhard Pfeifer

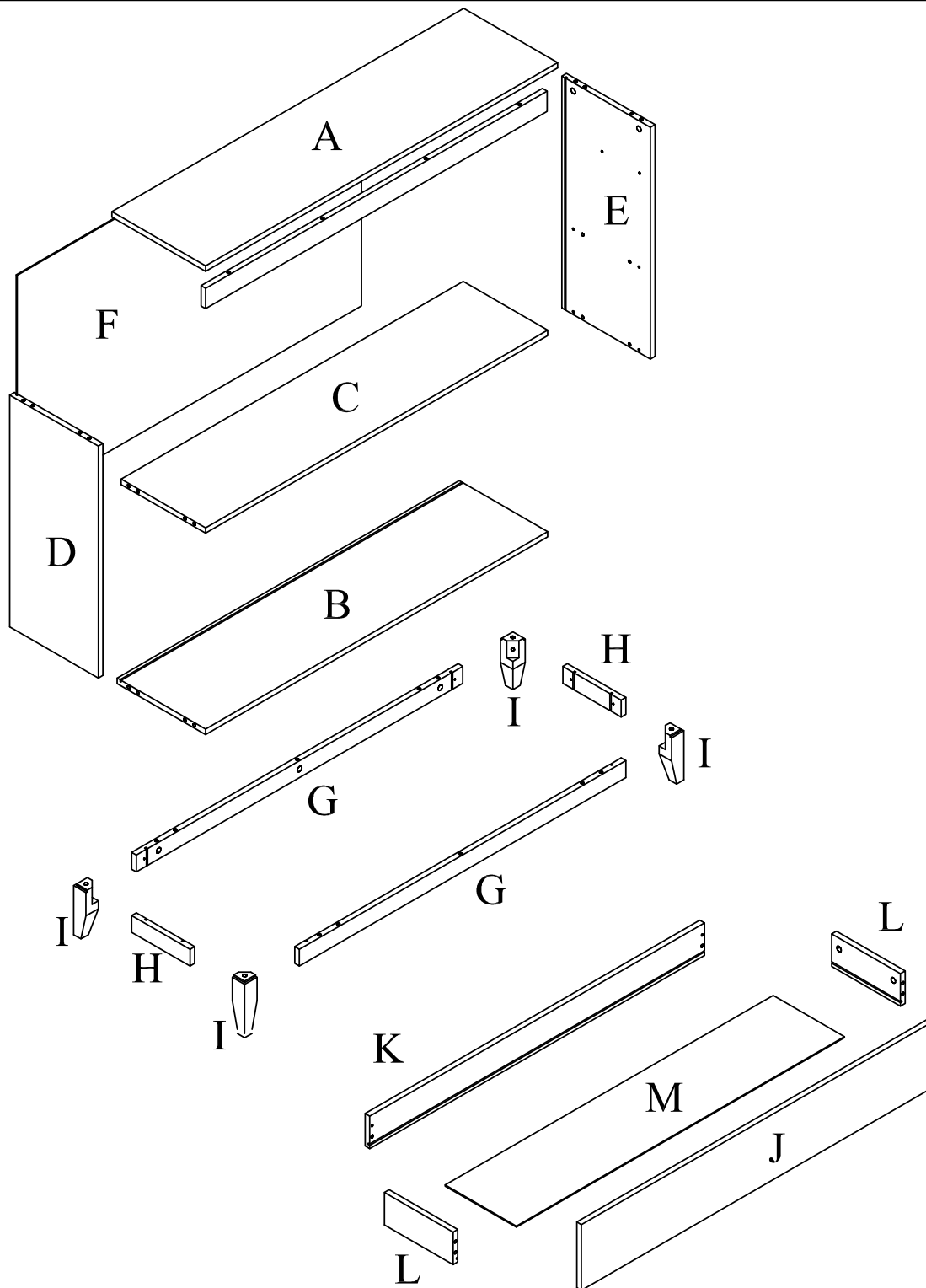

ENG - In case of any quality issues, contact your local dealer and always mention item reference No.

FR - En cas de problèmes de qualité, contactez votre revendeur local et mentionnez toujours la référence de l'article.









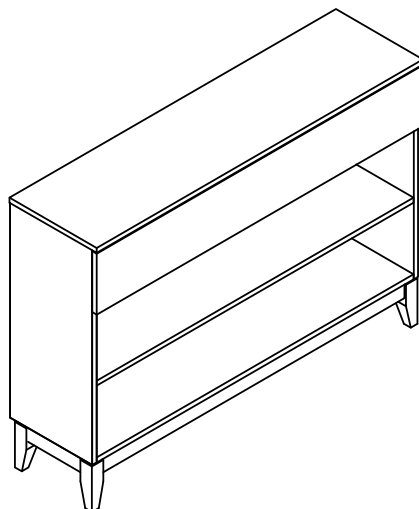

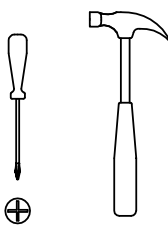
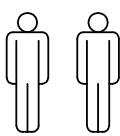
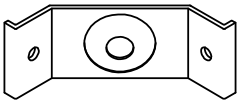
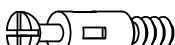

IT - In caso di eventuali problemi di qualità, contattare il rivenditore locale e citare sempre punto di riferimento No.

ES - En caso de problemas de calidad, póngase en contacto con su distribuidor local y mencione siempre la referencia del artículo.

DE - Wenn Sie Qualitätsprobleme haben wenden Sie sich bitte an ihren örtlichen Händler und erwähnen Sie immer die Artikelnummer.

Ruler - To help correctly identify the fittings

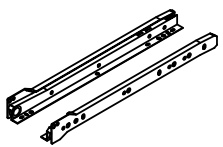
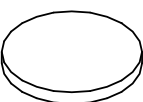

<p>A1</p>  <p>x20 Ø8x35</p>	 	<p>A8</p>  <p>x4</p>	
<p>A2</p>  <p>x26 Ø7x24</p>		<p>A9</p>  <p>x8 Ø3,5x16</p>	
<p>A3</p>  <p>x26</p>		<p>A10</p>  <p>x4 M6x40</p>	
<p>A4</p>  <p>x4 Ø3,0x15</p>		<p>A11</p>  <p>x4 M6/10x20</p>	
<p>A5</p>  <p>x4 Ø6,3x9</p>		<p>A12</p>  <p>x14 4mm</p>	
<p>A6</p>  <p>x4 Ø16</p>		<p>A13</p>  <p>x14 Ø3,0x20</p>	
<p>A7</p>  <p>x2 250mm</p>		<p>A15</p>  <p>x4 20mm</p>	<p>A14</p>  <p>x1 4mm</p>

step 3

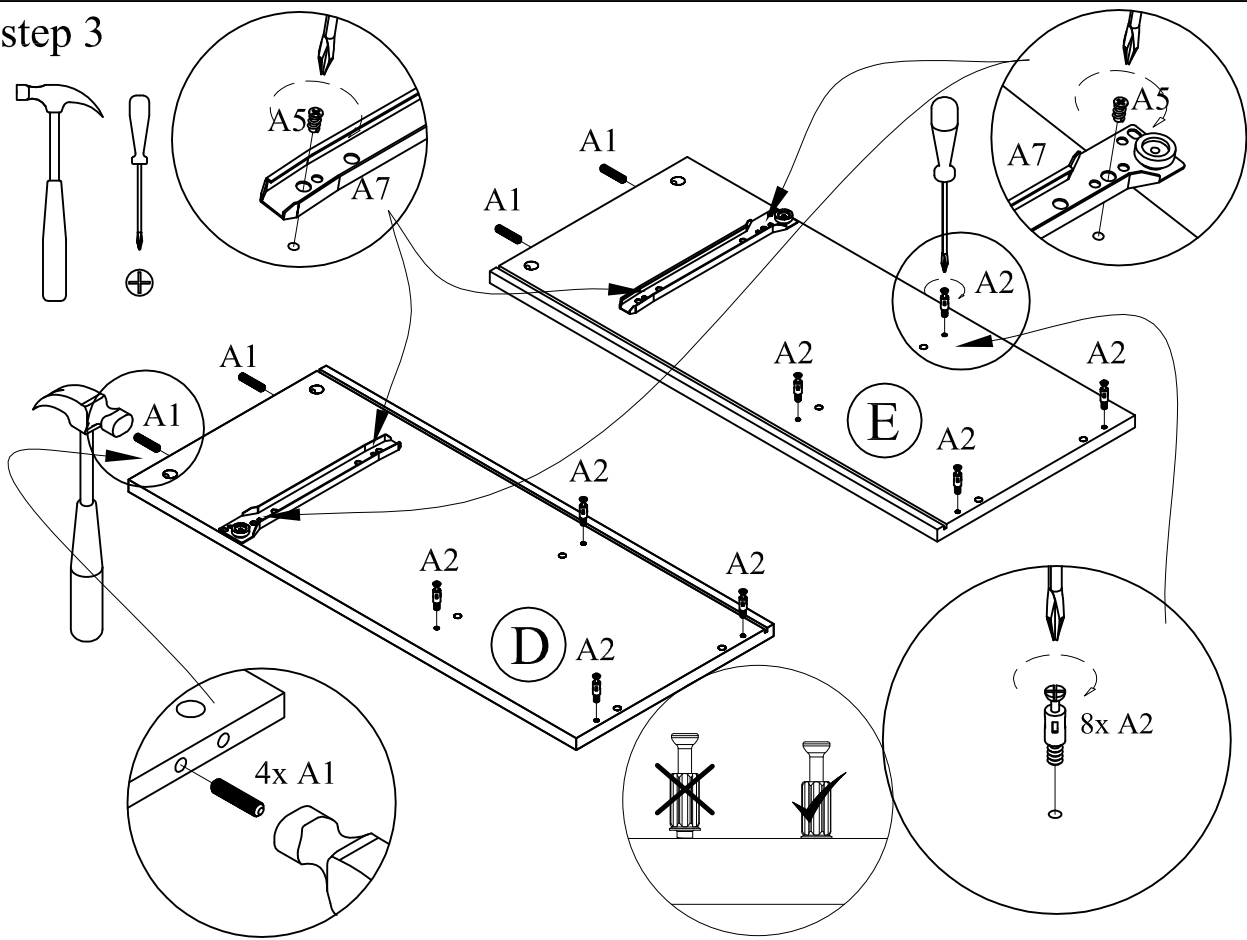

step 4

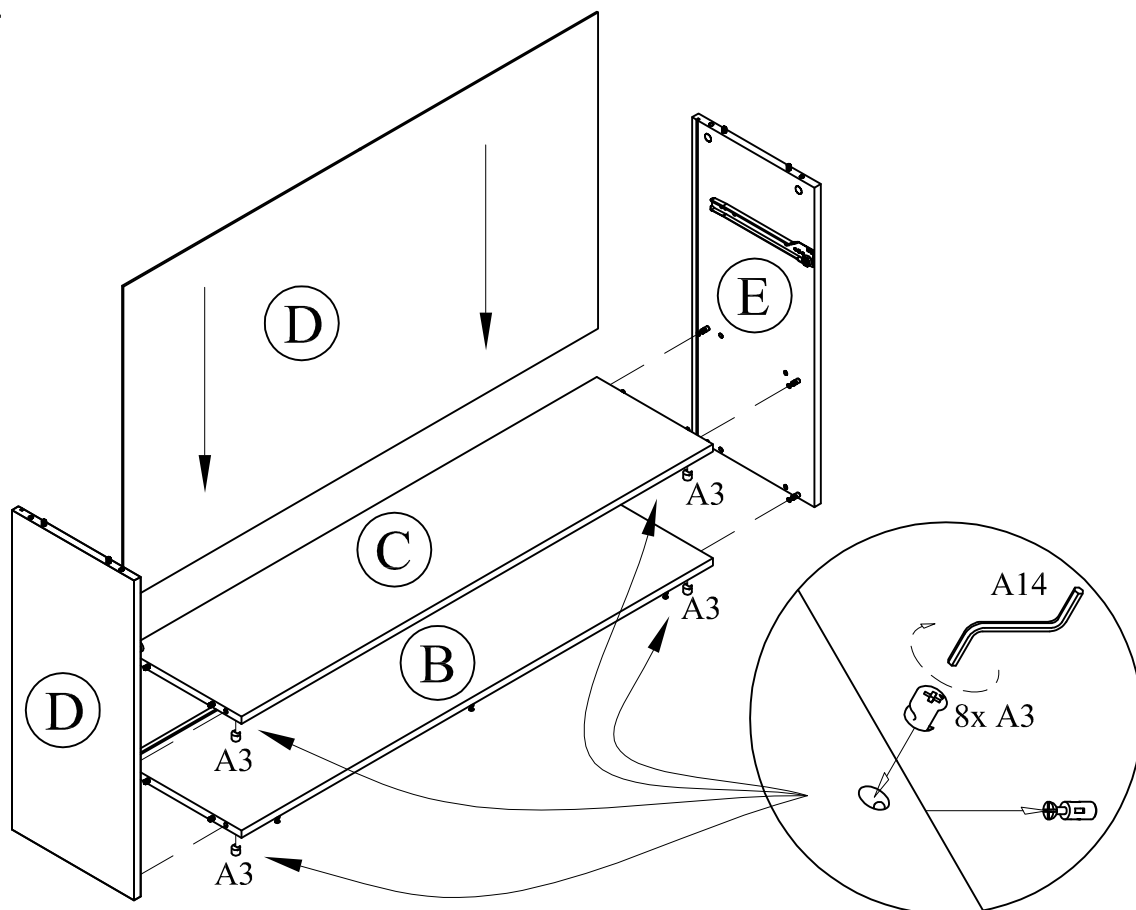

step 5

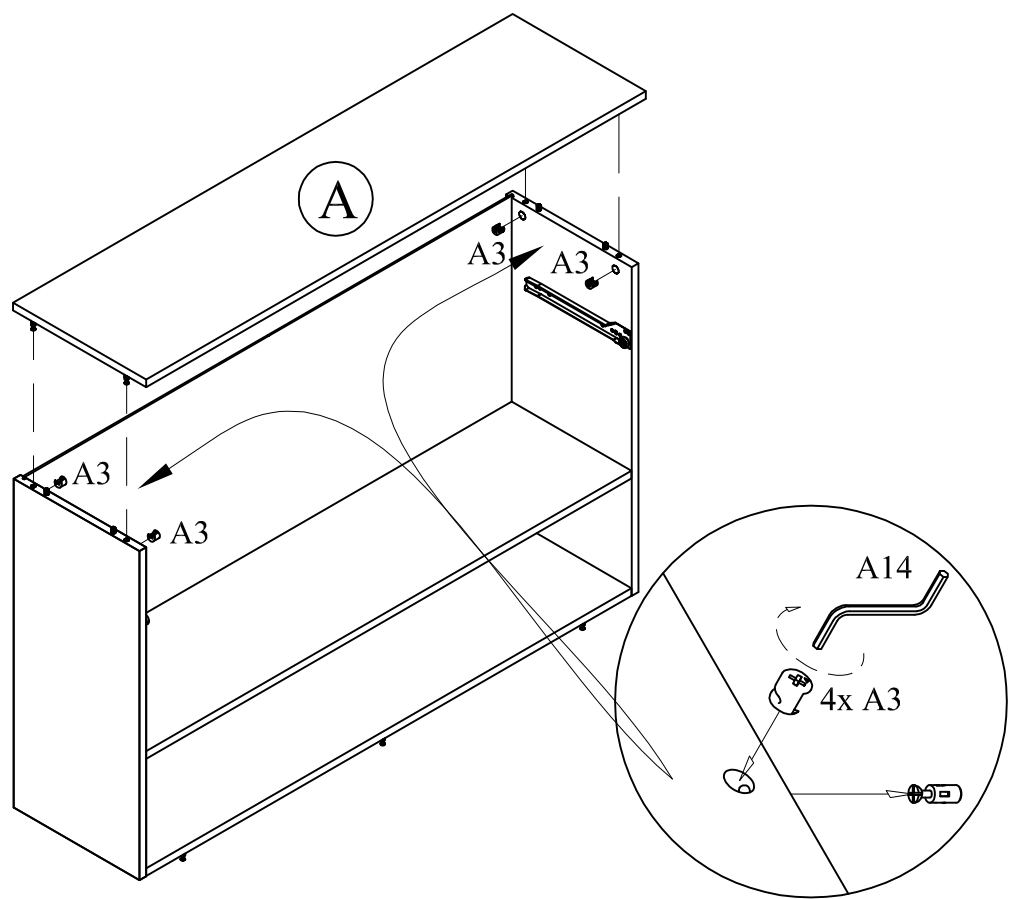

step 6

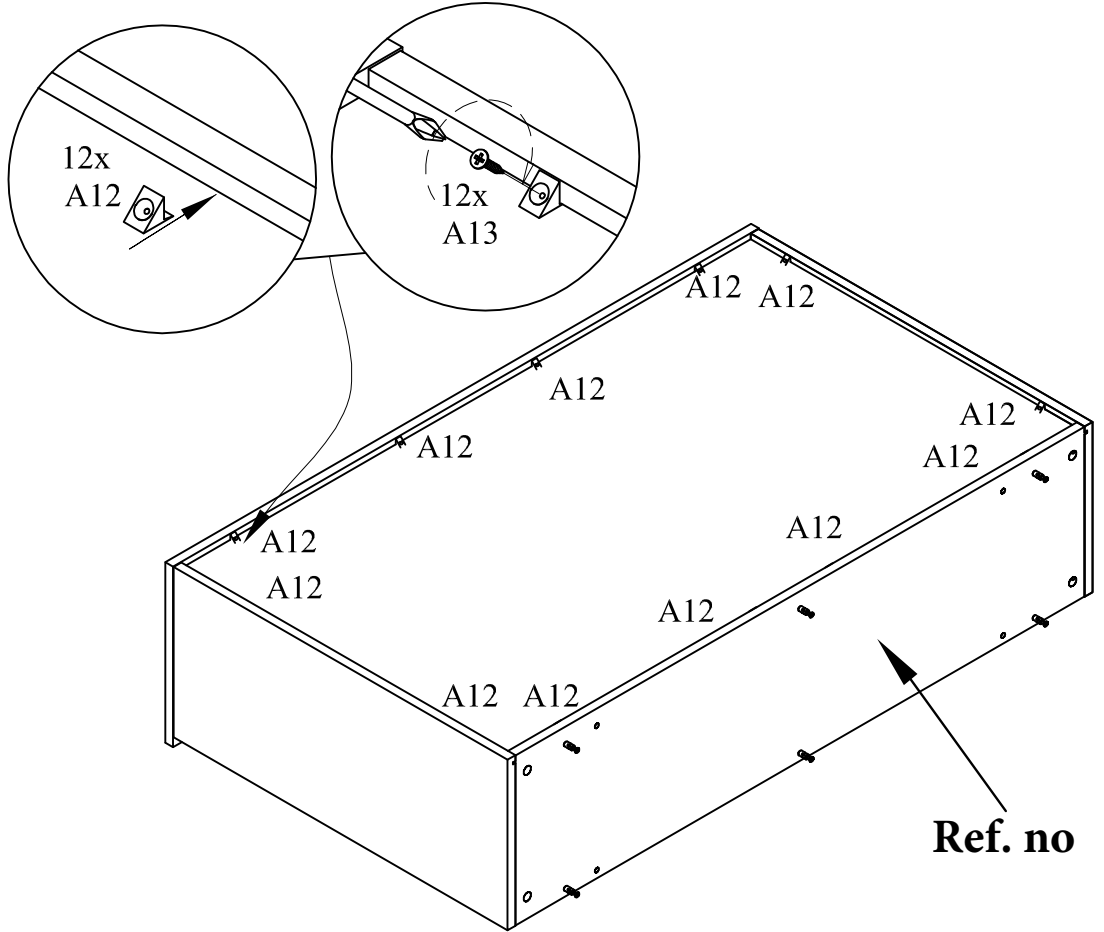

step 7

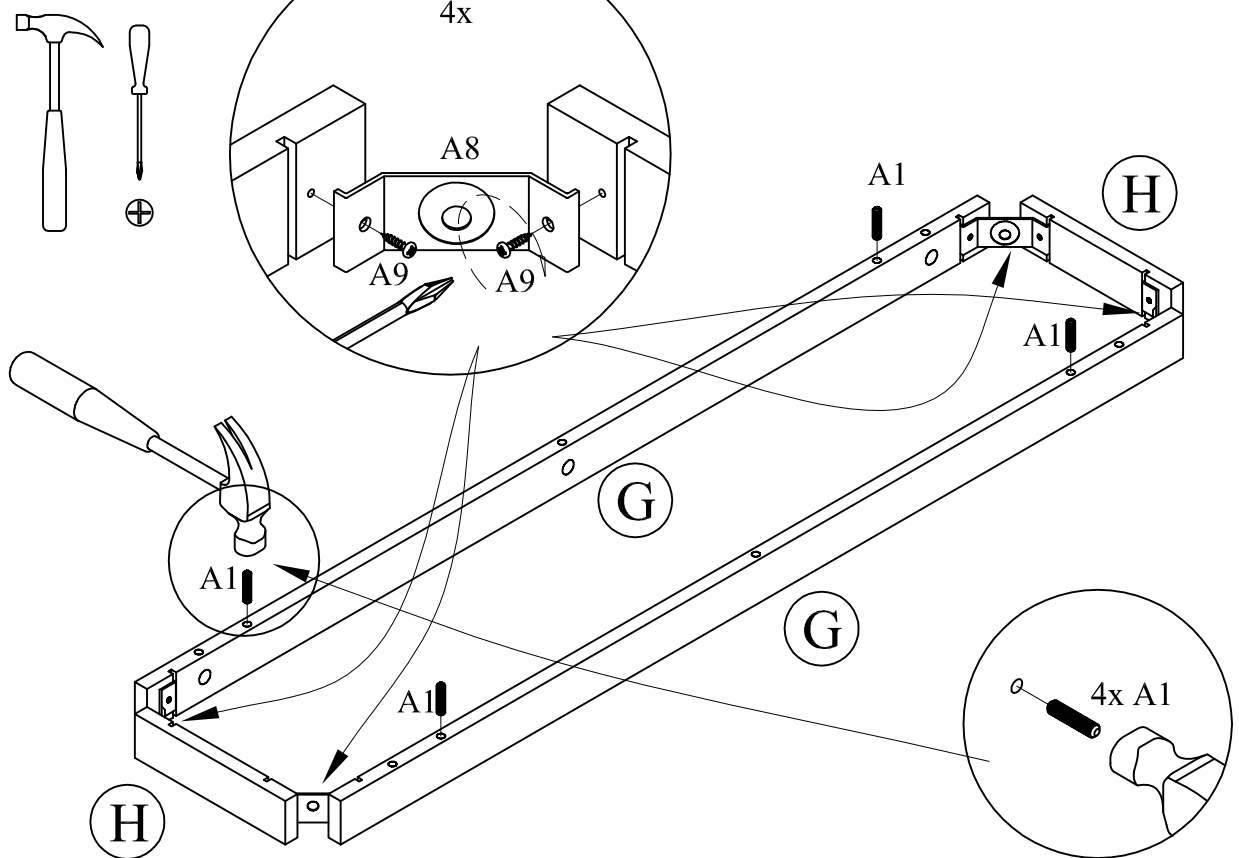

step 8

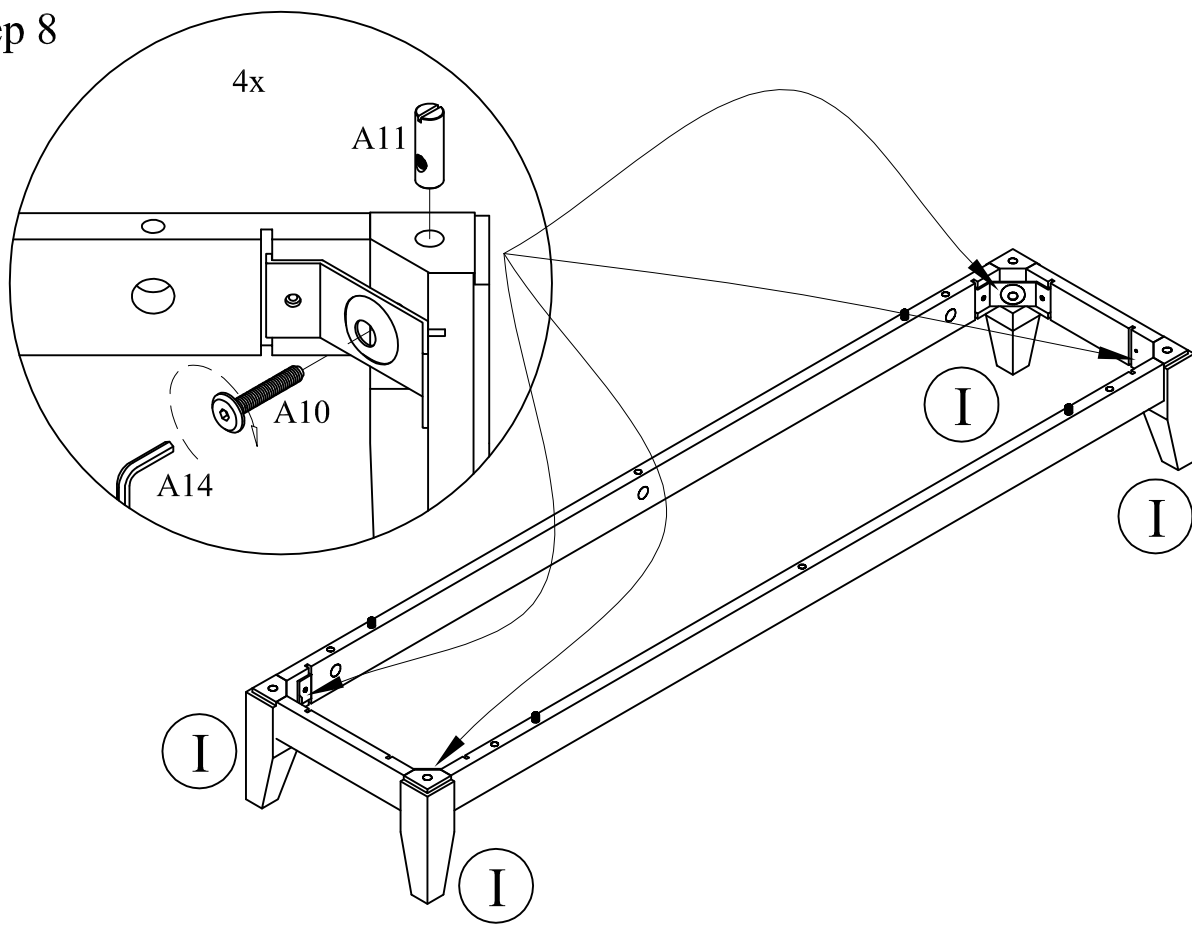

step 9

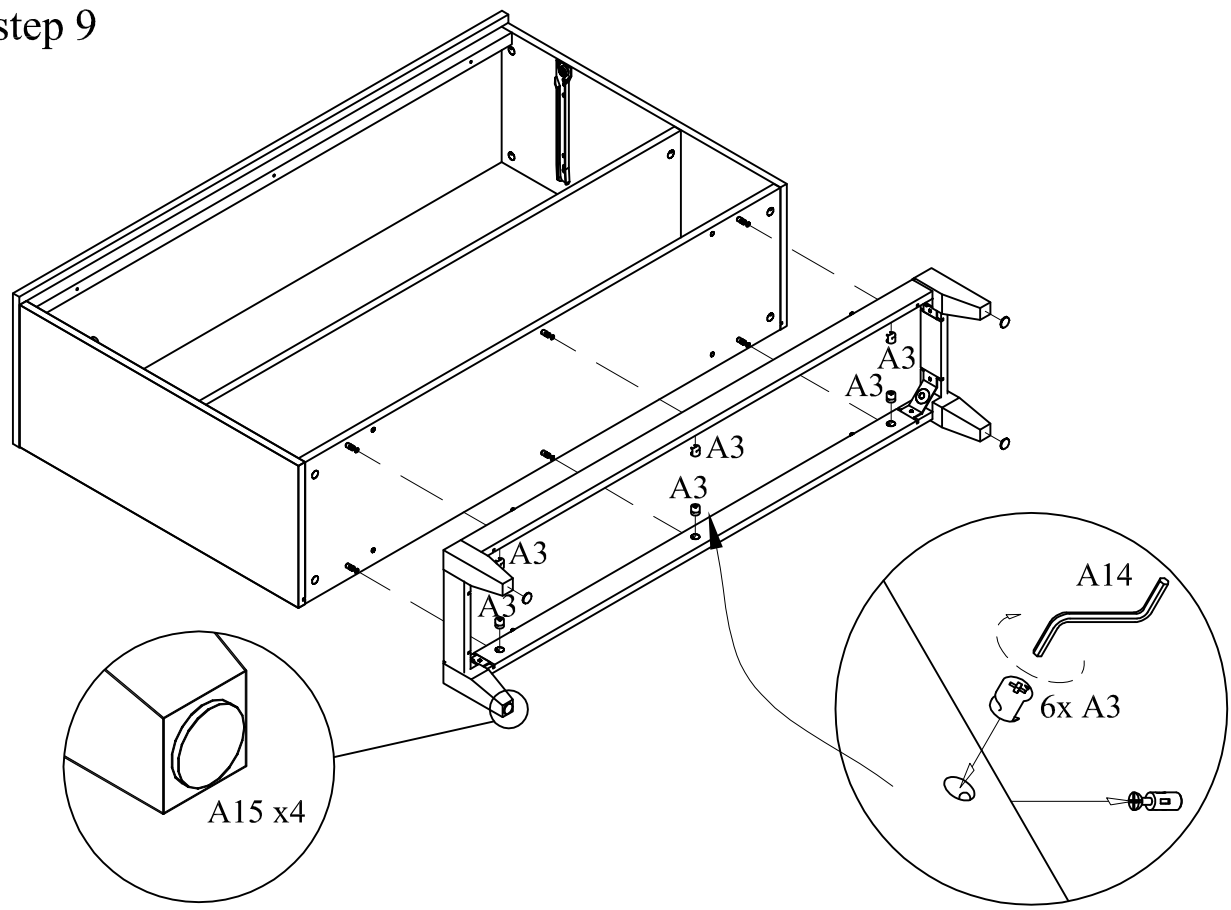

step 10

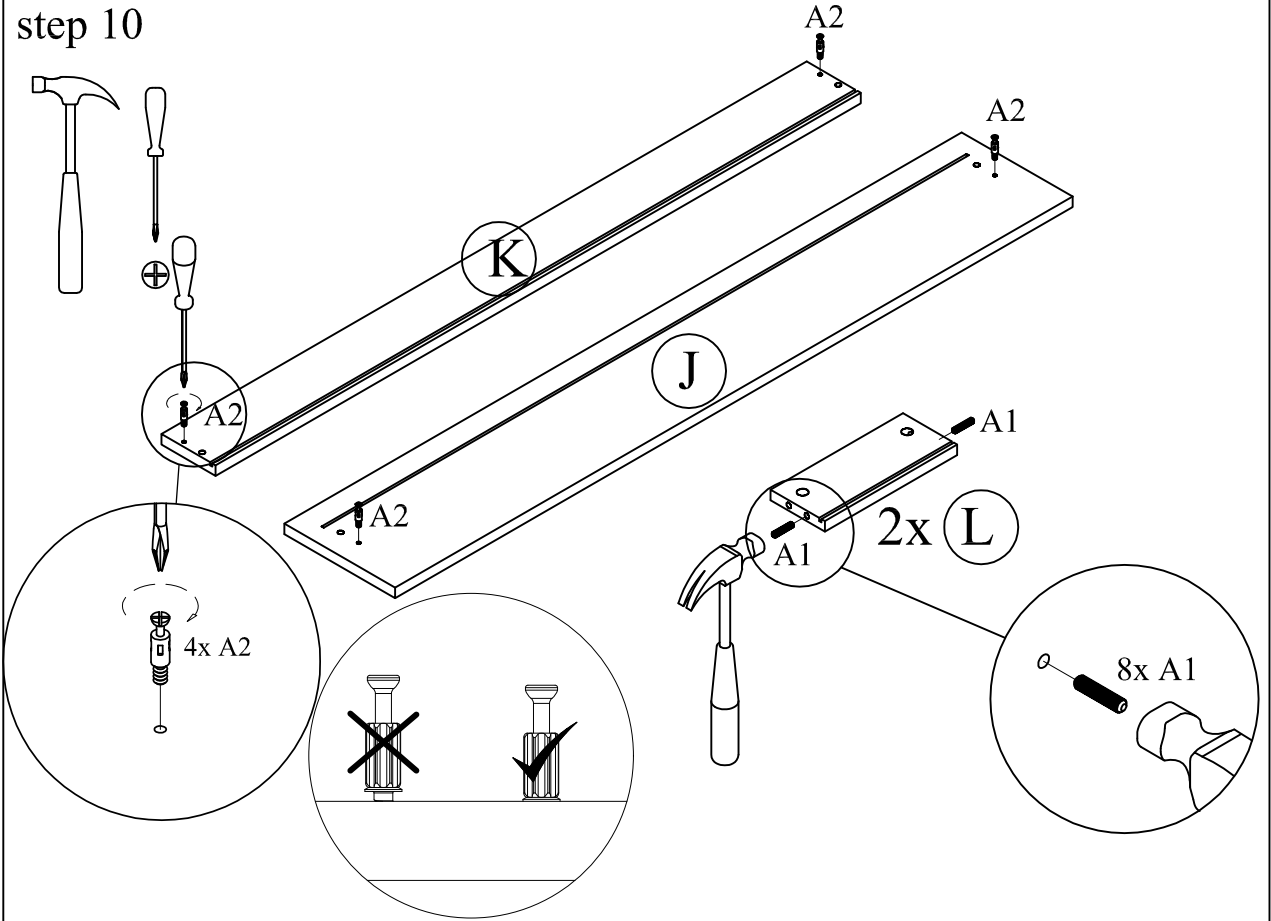

step 11

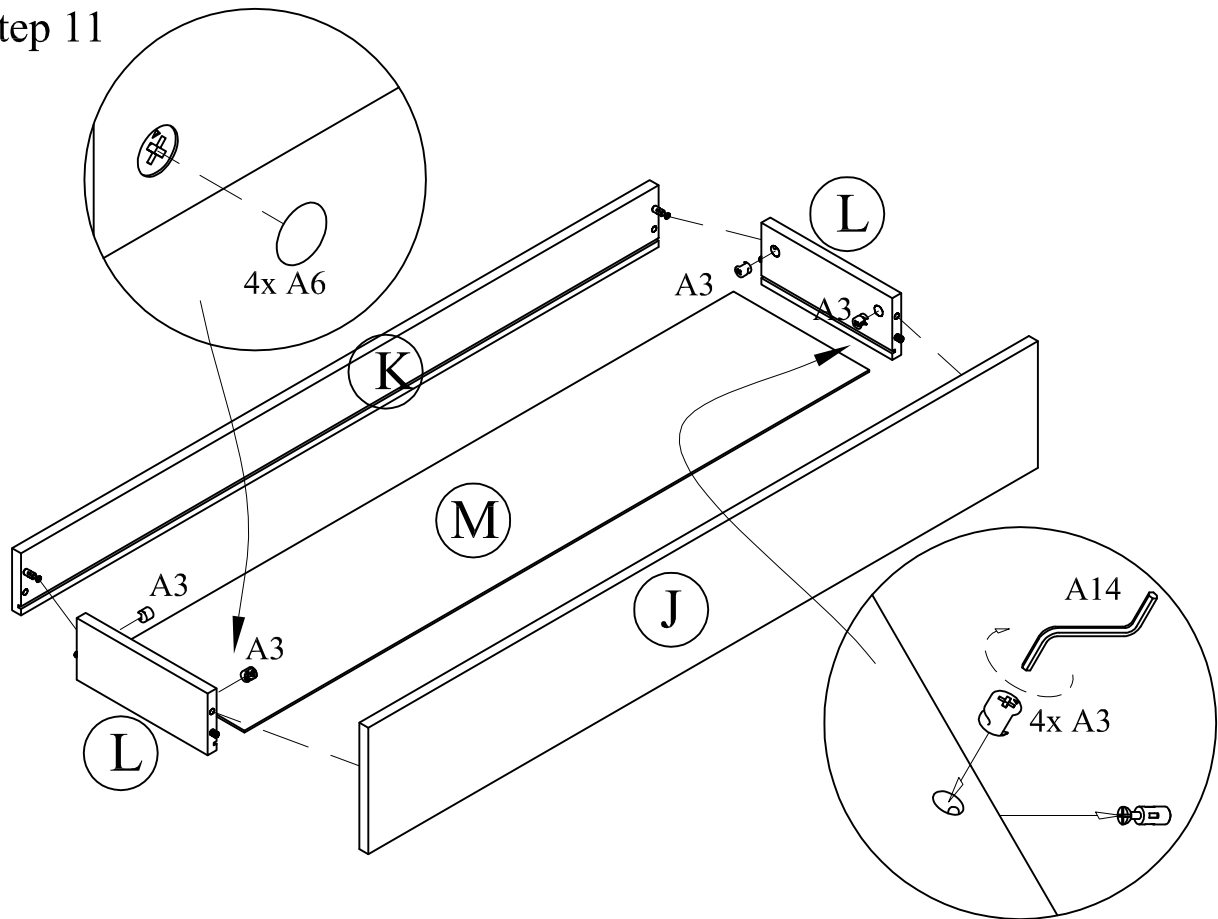

step 12

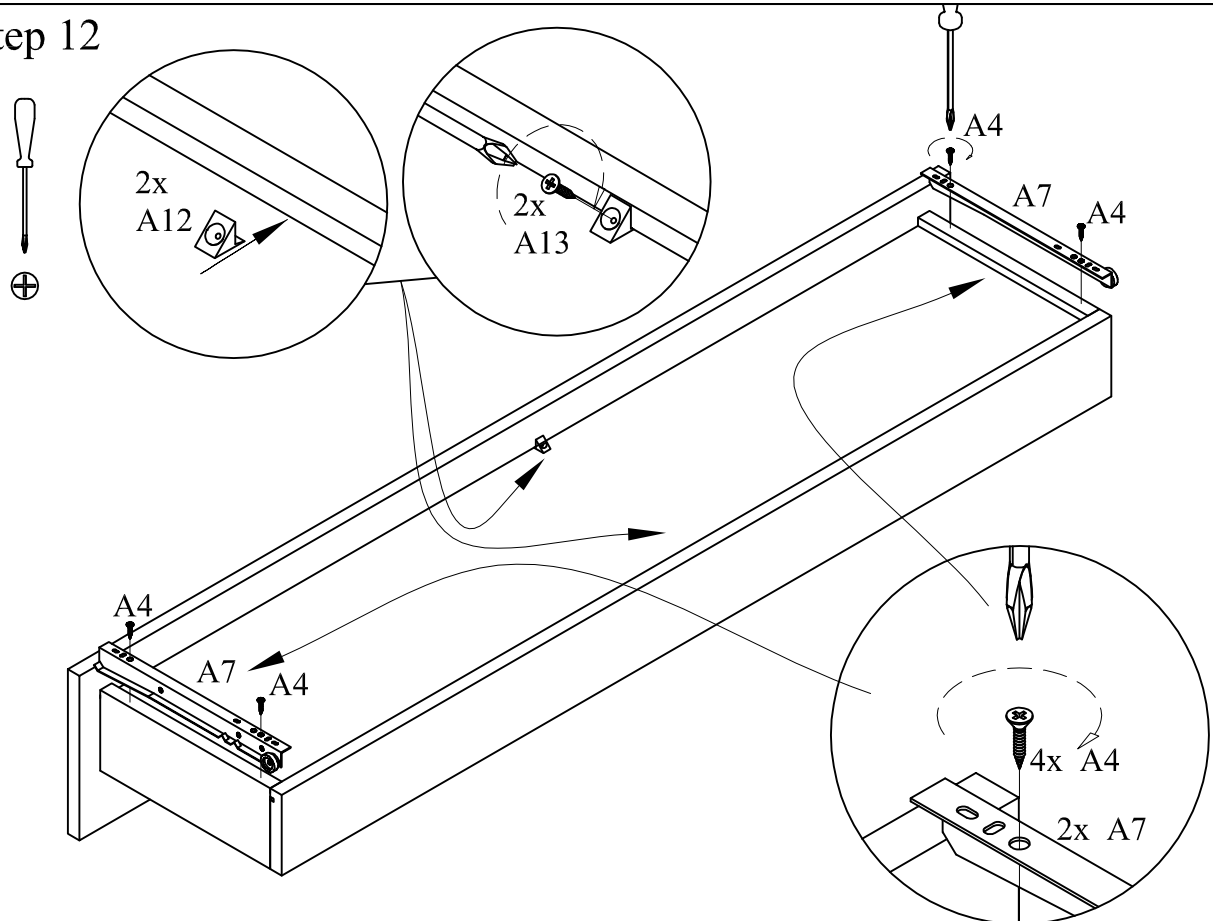

step 13

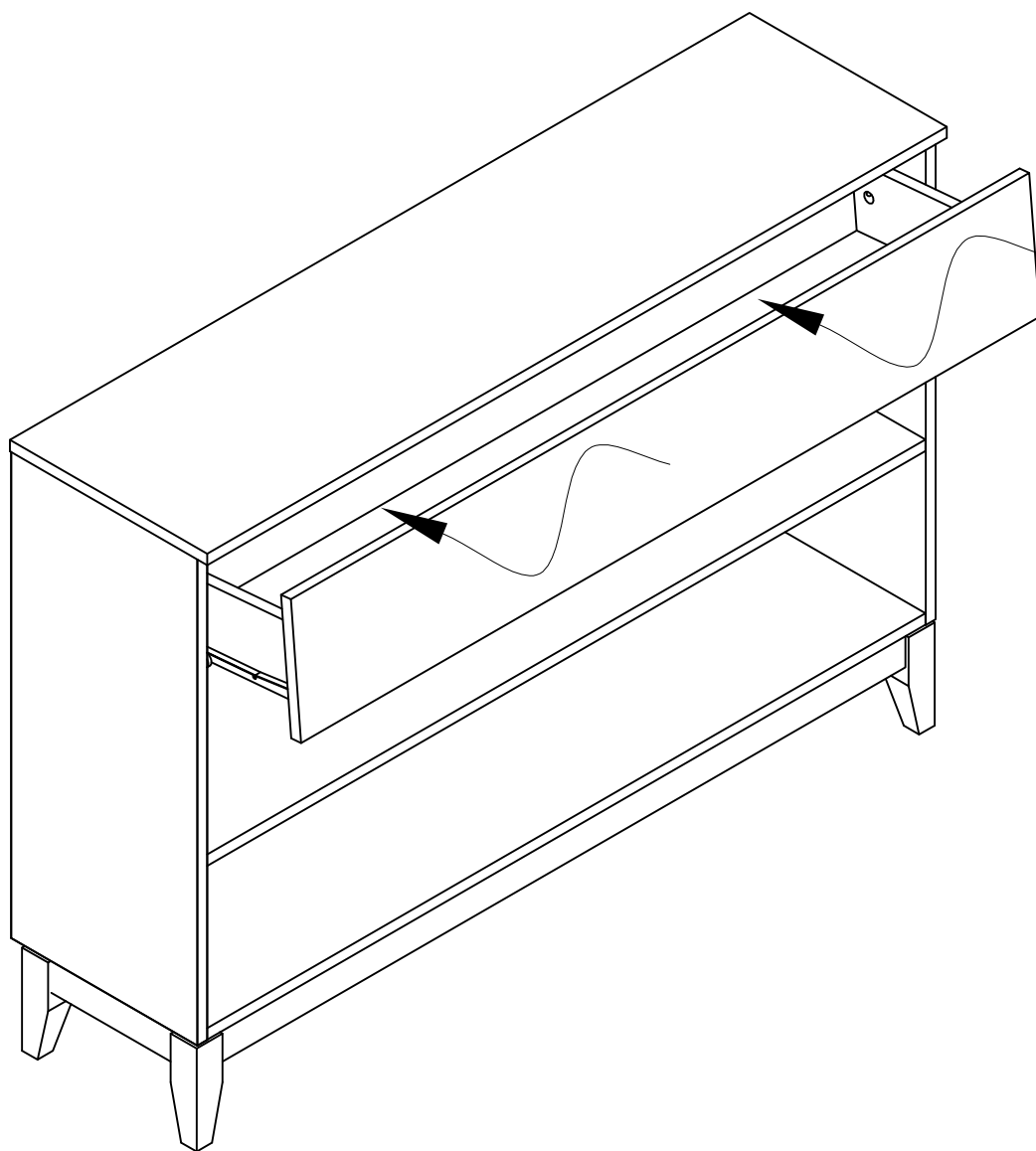



Safety and Care Advice

Important - Please read these instructions fully before starting assembly

Check you have all the components and tools.

Remove all fittings from the plastic bags and separate them into their groups.

Keep children and animals away from the work area, small parts could choke if swallowed.

Make sure you have enough space to layout the parts before starting.

Do not stand or put weight on the product, this could cause damage.

Assemble the item as close to its final position (in the same room) as possible. Do not place furniture directly in front of radiators, fires or any other source of heat.



Parts of the assembly will be easier with 2 people.

Assemble on a soft level surface to avoid damaging the unit or your floor.

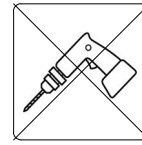

We do not recommend the use of power drill/drivers for inserting screws, as this could

damage the unit. Only use hand screwdrivers.

Dispose of all packaging carefully and responsibly.

General care and maintenance

Only clean using a damp cloth and mild detergent, do not use bleach or abrasive cleaners.

From time to time check that there are no loose screws and connectors on this unit.

This product should not be discarded with household waste. Take to your local authority waste disposal centre.

Cleaning and care of lacquered surfaces

Regular dusting with a dry cloth will keep your units clean.

Clean marks with a damp cloth.

Do not allow spillages to stay on the surface for long.

Do not clean with products containing the following: Acetone, (e.g nail varnish remover). Ammonia (e.g.bleach). or Sodium hydroxide (e.g. Caustic soda, drain and oven cleaners).

Do not use abrasive cleaners.

To remove stubborn stains, wipe over with a damp cloth and washing up liquid.

In the event of accidental contact with aggressive cleaners, rinse thoroughly with water.

Use place mats to protect the surface from moisture and heat.

Maximum weight limit

