

**NOTICE DE MONTAGE  
ASSEMBLY INSTRUCTIONS  
MONTAGEANLEITUNG  
ISTRUZIONI DI MONTAGGIO  
INSTRUÇÕES DE MONTAGEM  
INSTRUCCIONES DE MONTAJE  
UPUTE ZA MONTAZU  
MONTAJ TALIMATI**

**14544 - 15128**

ARMARIO 2P. CORREDERA  
WARDROBE 2 SLIDING DOORS  
ARMOIRE 2P. COULISSANTS

**ME**  
marckeric

MARCKERIC S.L.  
C / ENLACE VEROLA S/N,  
PC: 46430/SOLLANA / VALENCIA / SPAIN

**EAN CODE**

**843517838283  
8435178388940**

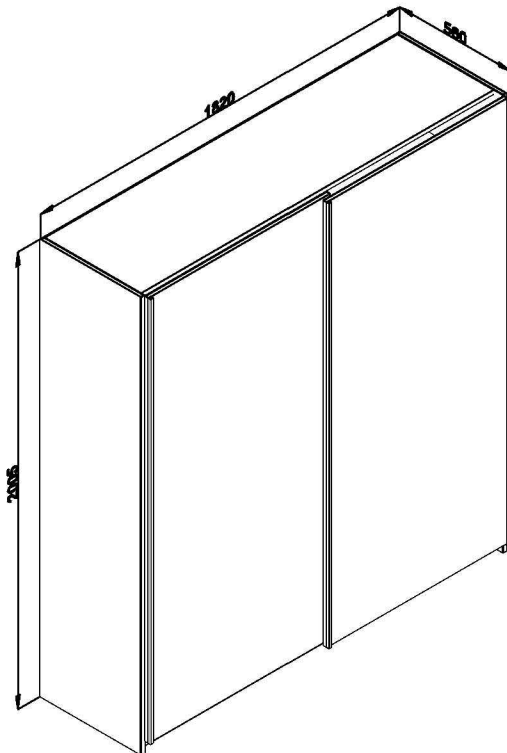

À MONTER SOI-MÊME

*AVANT DE COMMENCER, SE  
REPORTER AUX CONSEILS  
DE MONTAGE EN ANNEXE*

**BEFORE STARTING, REFER  
TO THE ASSEMBLING ADVICE  
IN ANNEX**

*VOR DER MONTAGE,  
BEILIEGENDE ANWEISUNGEN  
BEFOLGEN.*

*PRIMA DI COMINCIARE  
LEGGETE LE ISTRUZIONI DI  
MONTAGGIO*

*ANTES DE COMENÇAR, ADIAR  
SE AOS CONSELHOS DE  
MONTAGEM EM ANEXO*

**ANTES DE EMPEZAR  
CONSULTE LOS CONSEJOS  
PARA EL MONTAJE**

*PRIJE POČETKA MONTAŽE  
MOLIMO PAŽLJIVO  
PROČITAJTE UPUTE ZA  
MONTAŽU*

**BASLAMADAN ÖNCE,  
EKTEKI MONTAJ TALIMATLARINI  
İNCELEYİNİZ**

Caja Colis	Tamaño de la caja Dimensions colis	Peso bruto Poids brut	Peso neto Poids net
1/3	1993 x 927 x 47	46 Kg	45,1 Kg
2/3	2051 x 579 x 58	25 Kg	24,3 Kg
3/3	1949 x 516 x 90	42,5 Kg	41,6 Kg

"IMPORTANT- À CONSERVER POUR RÉFÉRENCE ULTÉRIEURE-LIRE ATTENTIVEMENT"

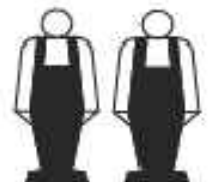
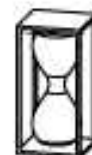

**2h:50 min**

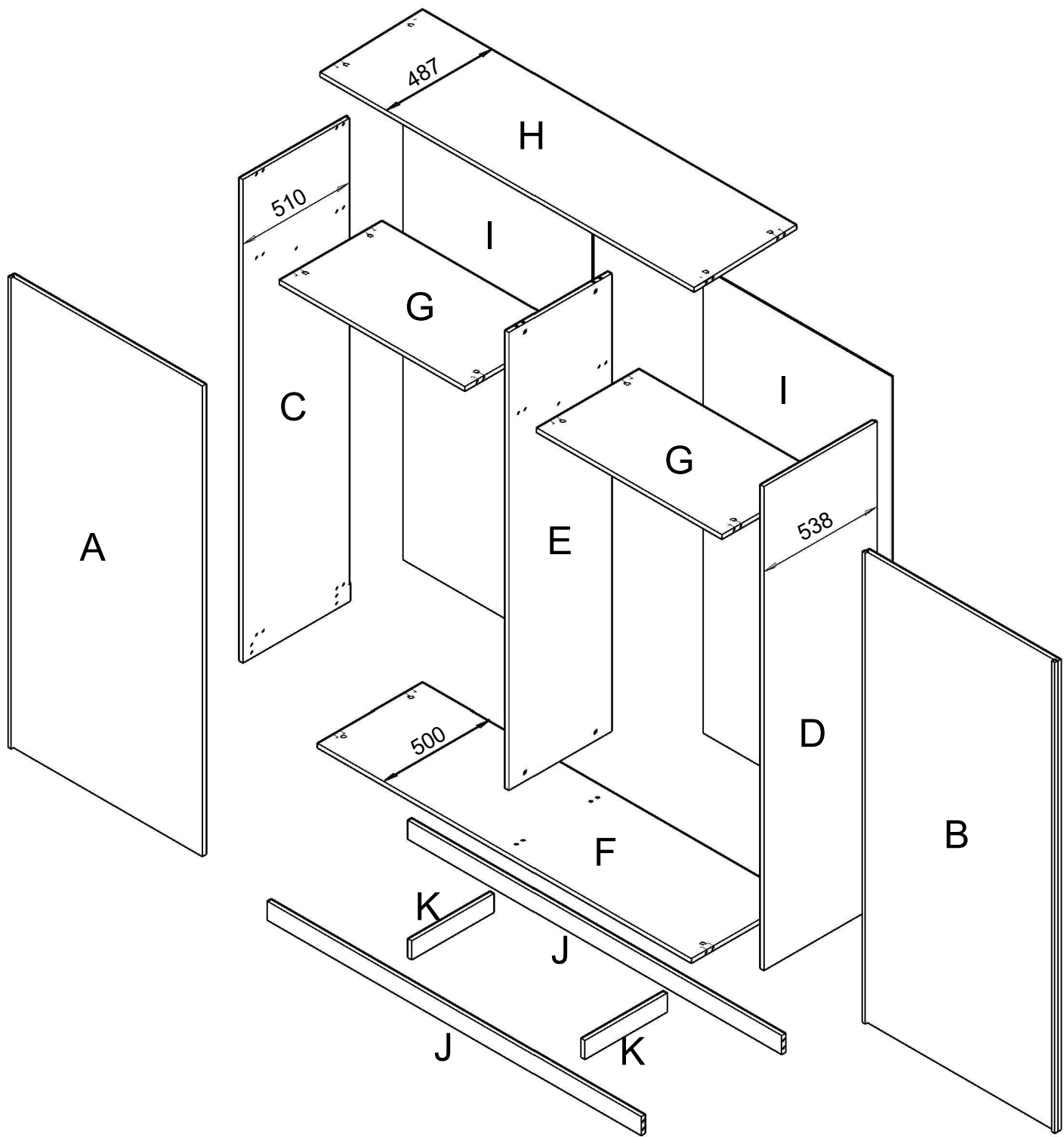

CAJA/COLIS 1/3	CAJA/COLIS 2/3	CAJA/COLIS 3/3
1x PIECE - A 1x PIECE - B 2x PIECES - I	1x PIECE - C 1x PIECE - D	1x PIECE - E 1x PIECE - H 1x PIECE - F 2x PIECES - G 2x PIECES - J 2x PIECES - K  QUINCALLERIE NOTICE DE MONTAGE

1x PIECE - A  
1x PIECE - B  
2x PIECES - I

1x PIECE - C  
1x PIECE - D



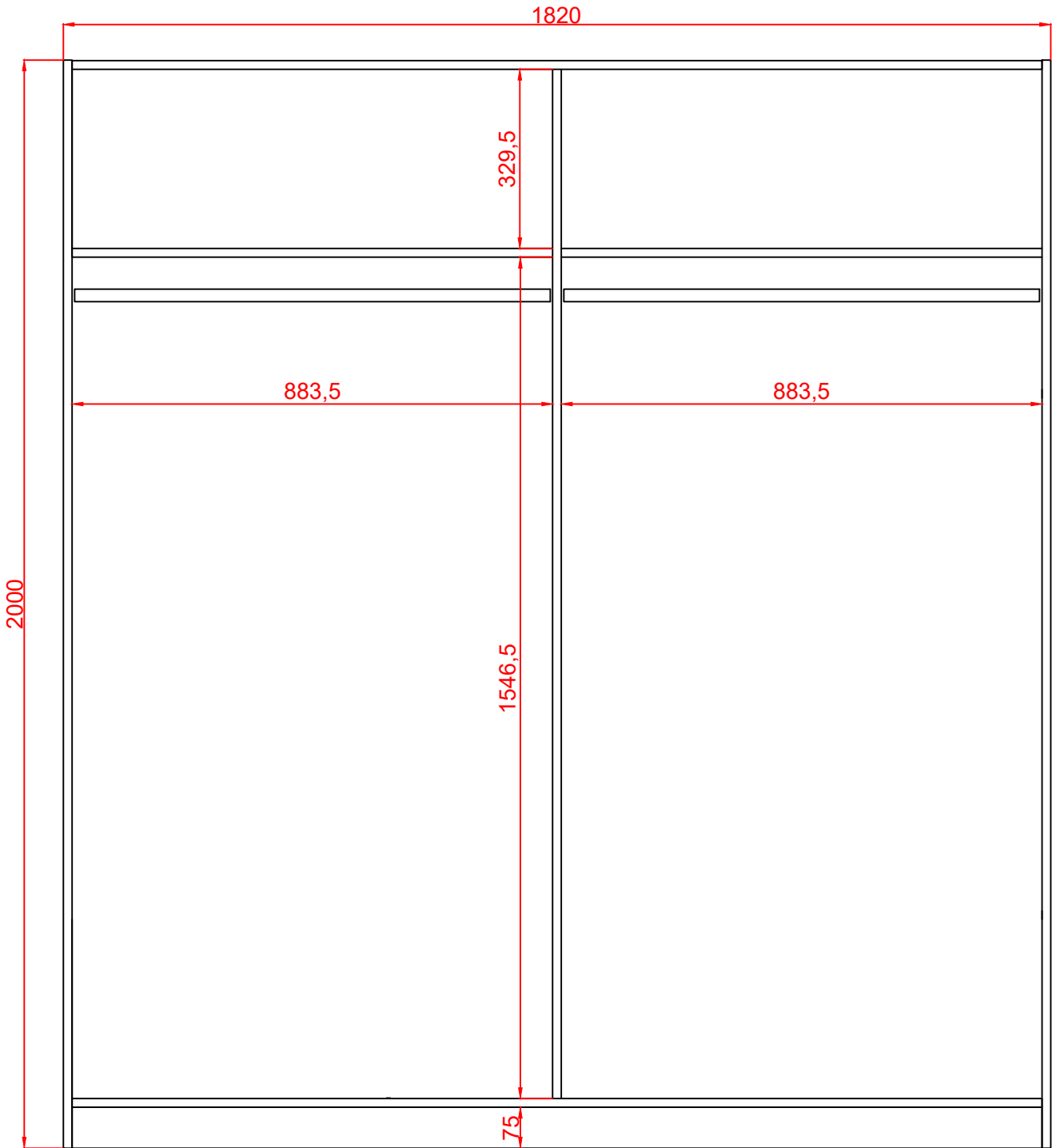

1x PIECE - E  
1x PIECE - H  
1x PIECE - F  
2x PIECES - G  
2x PIECES - J  
2x PIECES - K

QUINCALLERIE  
NOTICE DE  
MONTAGE



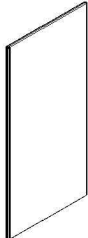
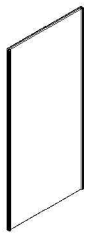
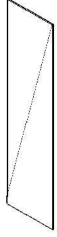

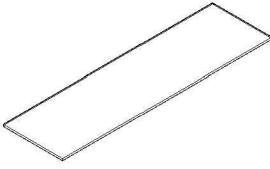
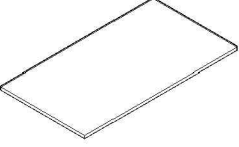
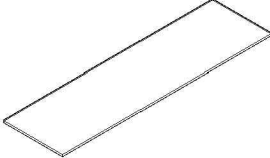
VISTA ALZADA

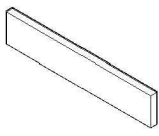
# LISTADO DE PIEZAS - COMPOSANTS - PARTS LIST

<p><b>A</b></p> 	<p><b>B</b></p> 
<p>1PU9015 1 Pc 914 x 1944 x 16</p>	<p>1PU9015 1 Pc 914 x 1944 x 16</p>
<p><b>C</b></p> 	<p><b>D</b></p> 
<p>1LA9336I 1 Pc 2000 x 510 x 16</p>	<p>1LA9336D 1 Pc 2000 x 538 x 16</p>
<p><b>E</b></p> 	<p><b>F</b></p> 
<p>1LA9337 1 Pc 1892 x 487 x 16</p>	<p>1SI9083 1 Pc 1783 x 500 x 16</p>
<p><b>G</b></p> 	<p><b>H</b></p> 
<p>1SI9085 2 Pc 883.5 x 487 x 16</p>	<p>1SI9084 1 Pc 1783 x 487 x 16</p>
<p><b>I</b></p> 	<p><b>J</b></p> 
<p>MTB1647 2 Pc 1922 x 899 x 3</p>	<p>1ZA8262 2 Pc 1783 x 75 x 16</p>
<p><b>K</b></p> 	
<p>1VA8703 2 Pc 390 x 75 x 16</p>	

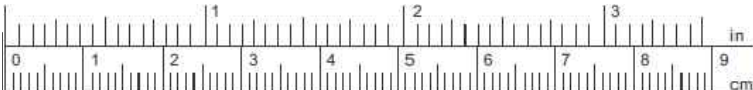
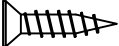
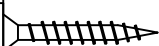

# HERRAJES - QUINCALLERIE - HARDWARE

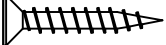
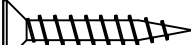
②  x78 <b>MTR0420</b> 3,5x15	③  x42 <b>MTR0610</b> 3x20	⑤  x42 <b>MTR0641</b> 6,3x11	⑦  x2 <b>MTR0770</b>	⑧  x16 <b>MTR0715</b>	⑮  x20 <b>MTR0720</b>
⑮  x28 <b>MVA0090</b>	⑰  x6 <b>MTA0020</b>	⑲  x6 <b>MTR0541</b>	⑳  x11 <b>MGR0110</b>	㉔  x1 <b>MCL0090</b>	㉗  x2 <b>MBC0307</b>
⑳  x4 <b>MSP0060</b>	㉓  x11 <b>MTR0210</b> 3x20	㉔  x2 <b>MVA1958</b> TOR.FRENO	㉘  x2 <b>MVA1959</b>	㉙  x1 <b>MVA1957</b> PERFIL SUP.	④  x1 <b>MVA1958</b> PERFIL INF.
④  x1 <b>MVA1959</b> FRENO	④  x2 <b>MVA1959</b> PATIN INF.DER	④  x2 <b>MVA1959</b> PATIN INF.IZQ.	④  x3 <b>MVA1956</b>	④  x2 <b>MVA1956</b> SUP.DCHA	④  x1 <b>MVA1956</b> SUP.IZQ.
④  x1 <b>MVA1959</b> SUP.IZQ.	④  x1 <b>MTR0250</b> 3,5x25				



			
②			3,5x15
③			3x20
⑤			6,3x11
⑮			8x30
㉓			3x20
㉔			3,5x25

**1**

"UTILISATION D'UNE COUVERTURE RECOMMANDÉE AFIN DE NE PAS ABIMER LES PIÈCES LORS DU MONTAGE"

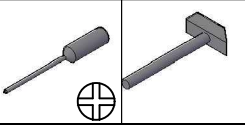
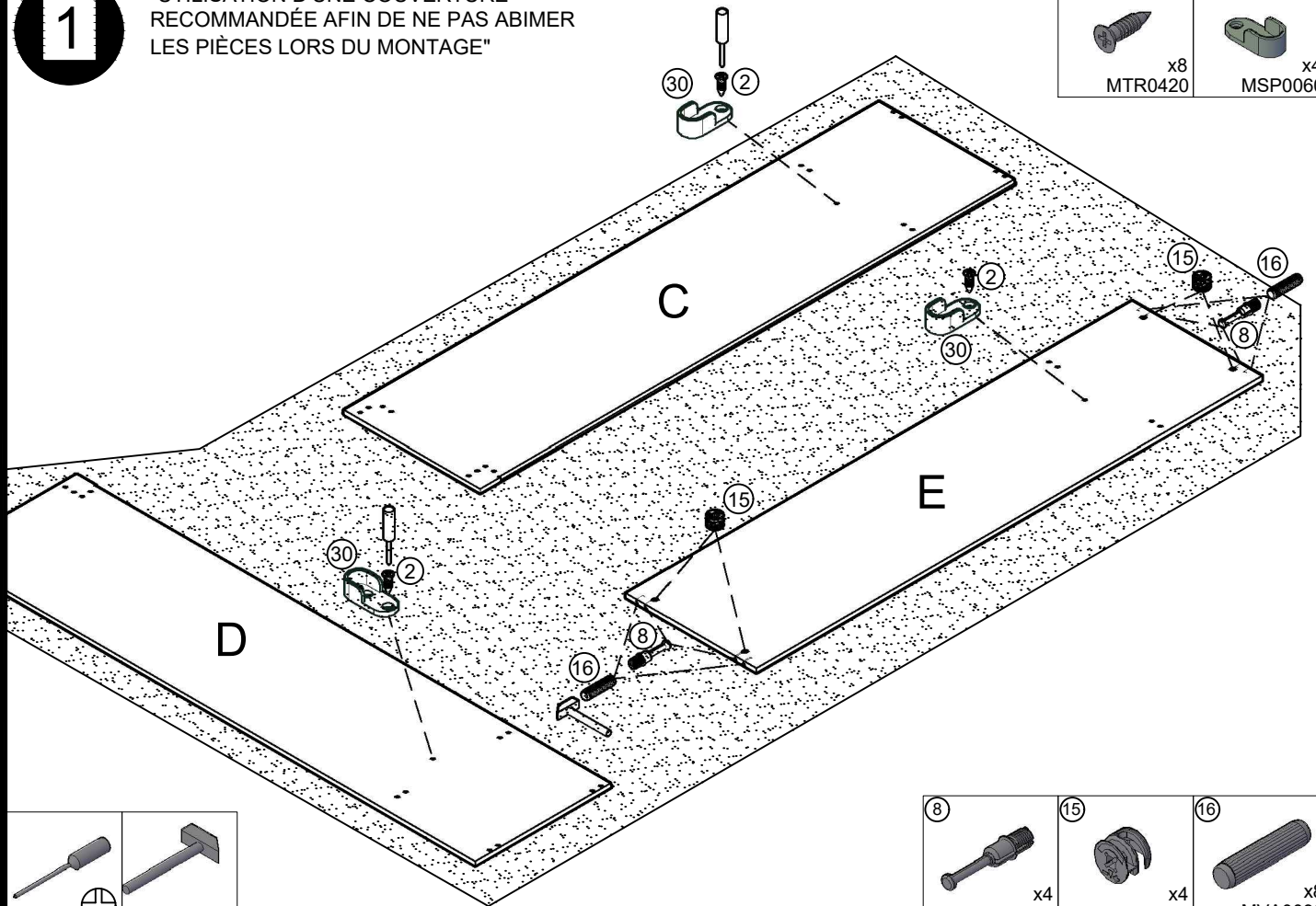
- |          |  |           |  |
|----------|--|-----------|--|
| <b>2</b> | <br>x8<br>MTR0420 | <b>30</b> | <br>x4<br>MSP0060 |
|----------|--|-----------|--|







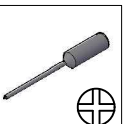
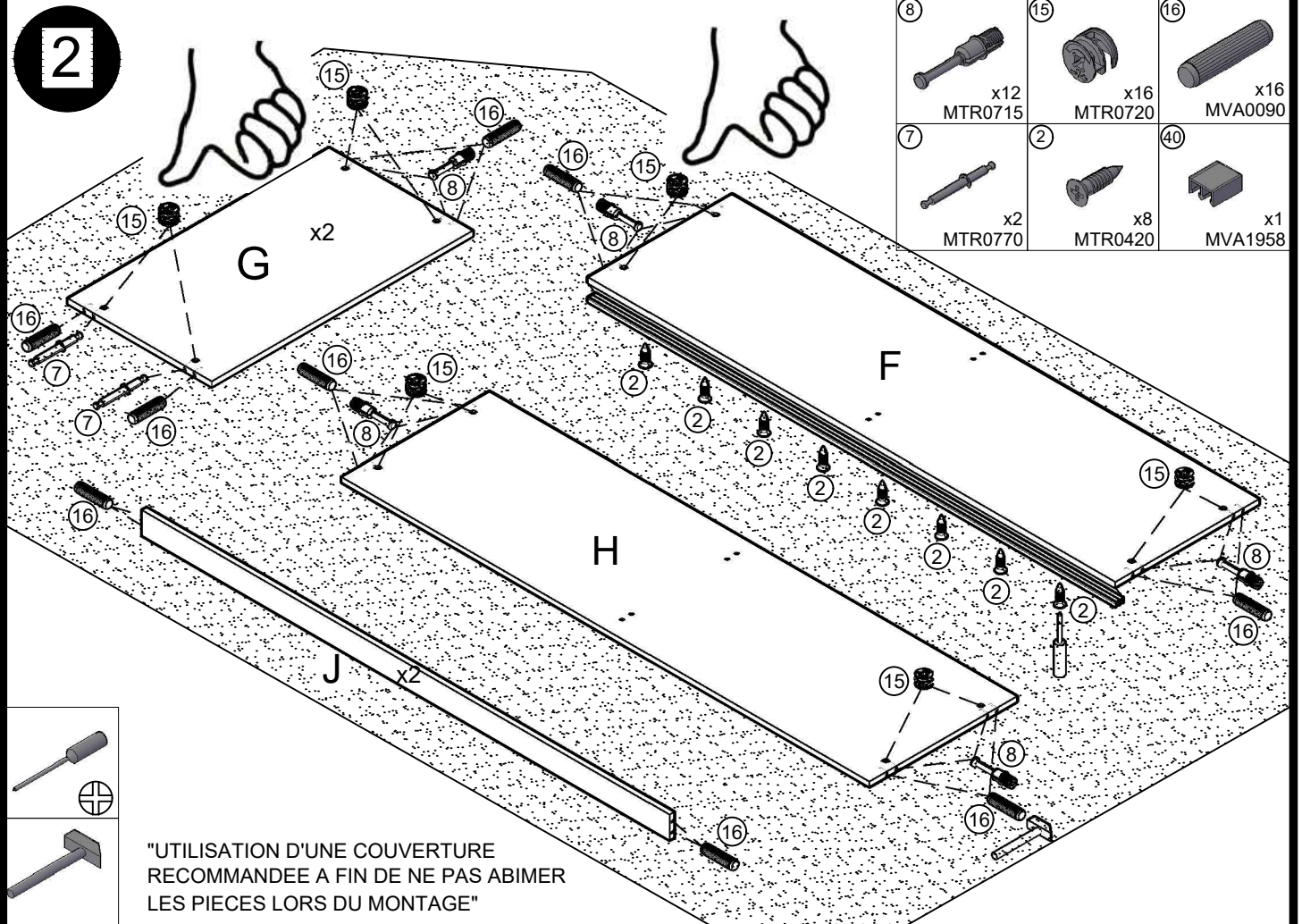

- |          |  |           |  |           |  |
|----------|--|-----------|--|-----------|--|
| <b>8</b> | <br>x4<br>MTR0715 | <b>15</b> | <br>x4<br>MTR0720 | <b>16</b> | <br>x8<br>MVA0090 |
|----------|--|-----------|--|-----------|--|

**2**

"UTILISATION D'UNE COUVERTURE RECOMMANDÉE A FIN DE NE PAS ABIMER LES PIÈCES LORS DU MONTAGE"



- |          |   |           |   |           |   |
|----------|---|-----------|---|-----------|---|
| <b>8</b> | <br>x12<br>MTR0715 | <b>15</b> | <br>x16<br>MTR0720 | <b>16</b> | <br>x16<br>MVA0090 |
| <b>7</b> | <br>x2<br>MTR0770  | <b>2</b>  | <br>x8<br>MTR0420  | <b>40</b> | <br>x1<br>MVA1958  |

"UTILISATION D'UNE COUVERTURE RECOMMANDÉE A FIN DE NE PAS ABIMER LES PIÈCES LORS DU MONTAGE"

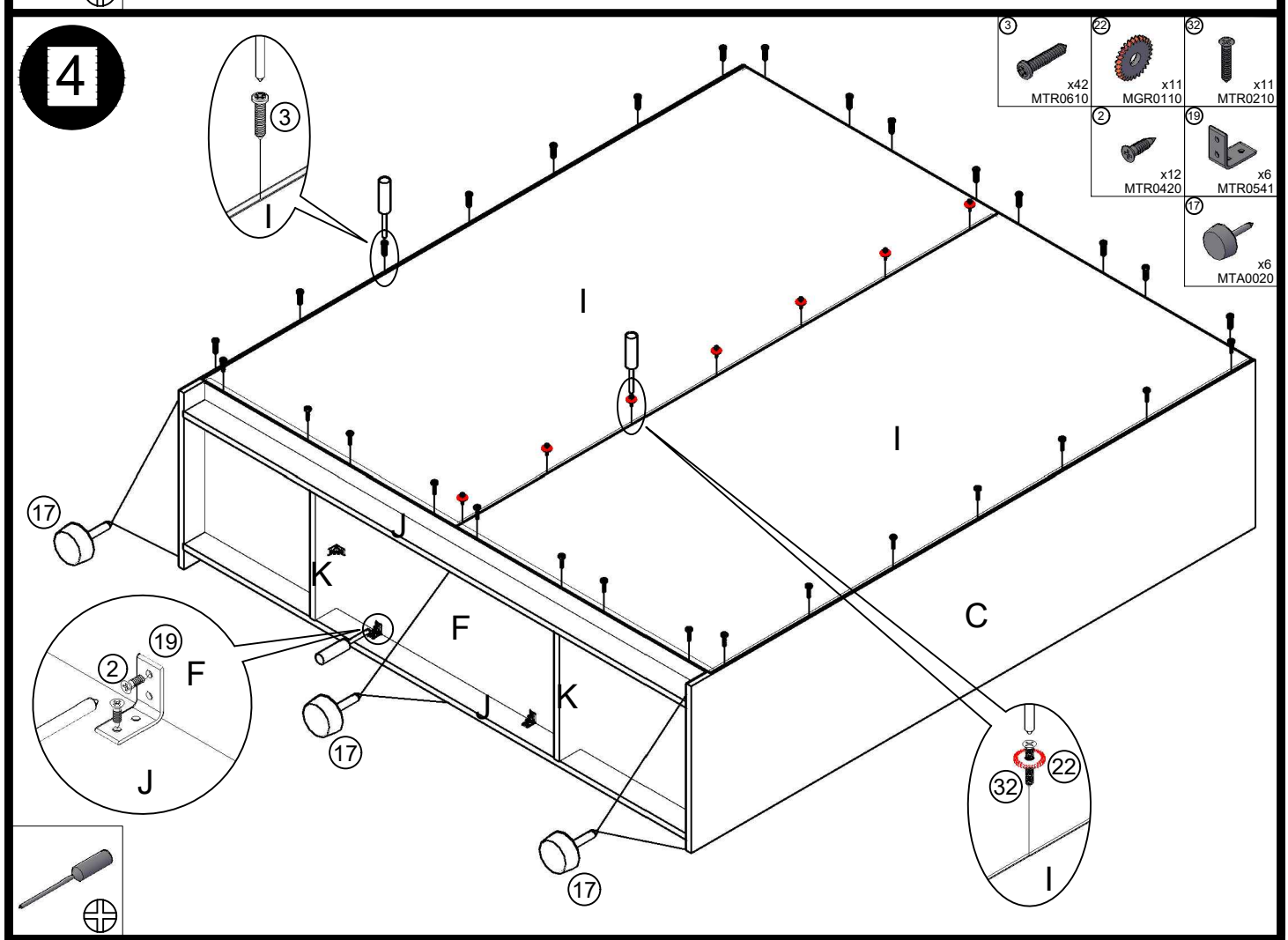
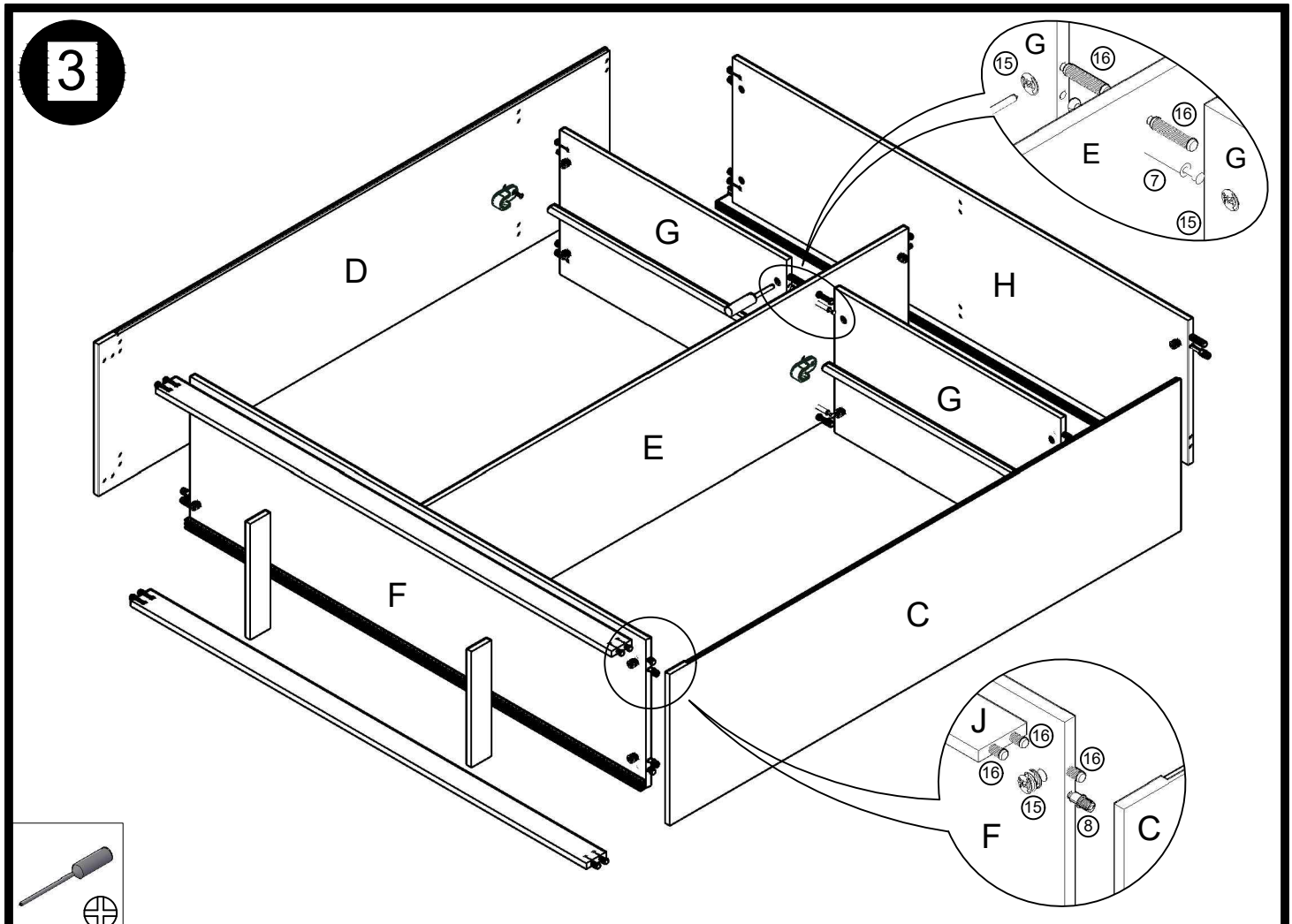

5

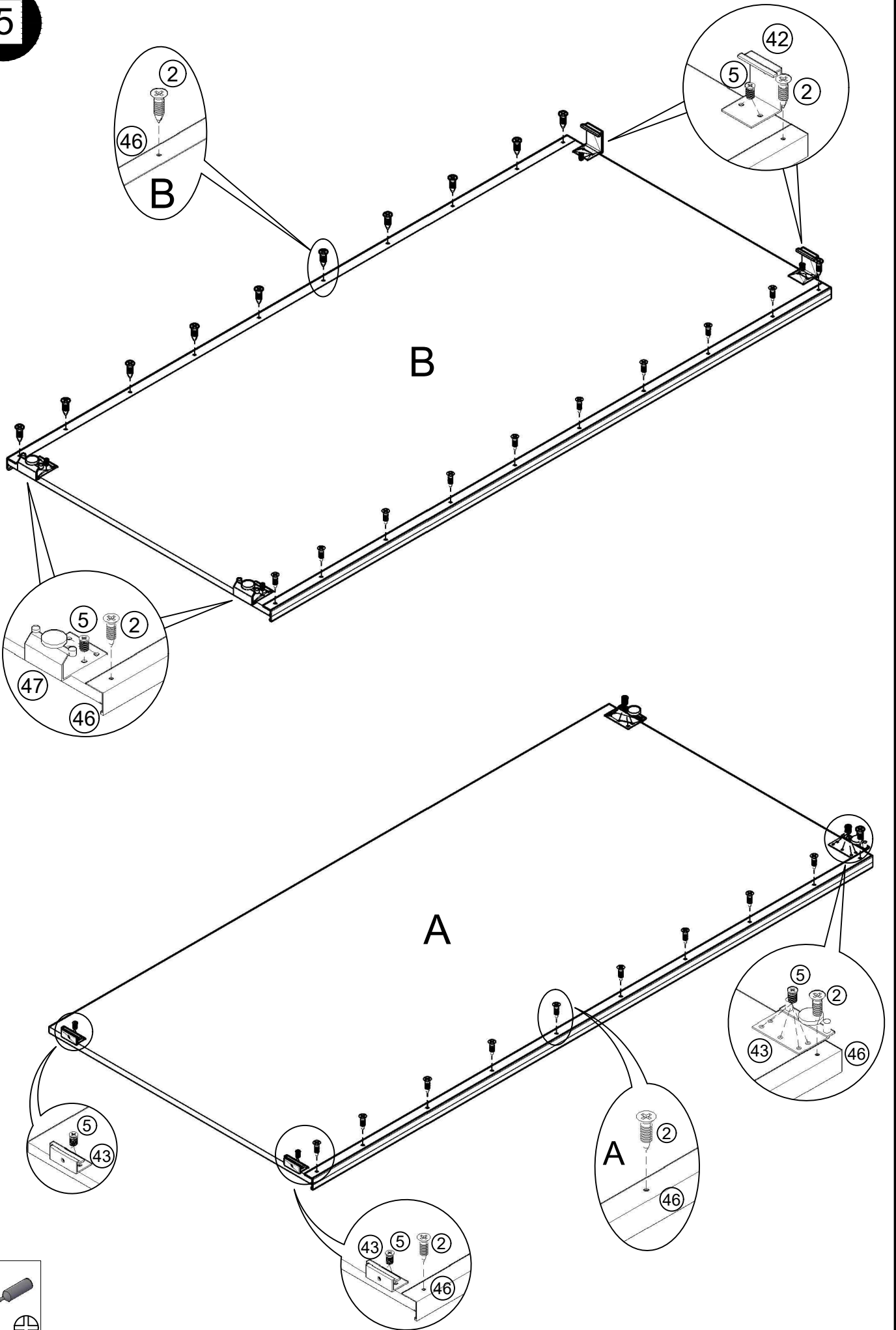



6

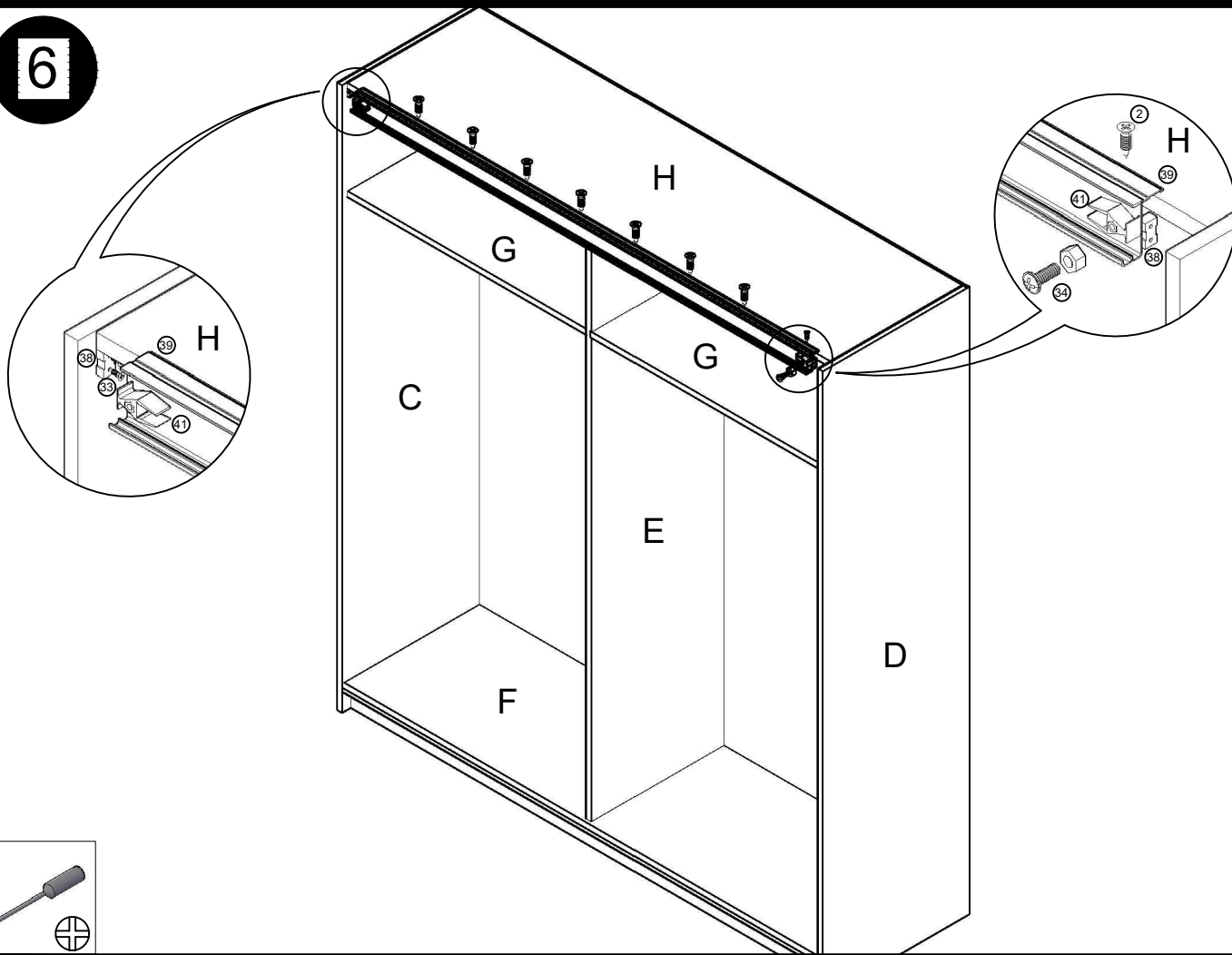

7

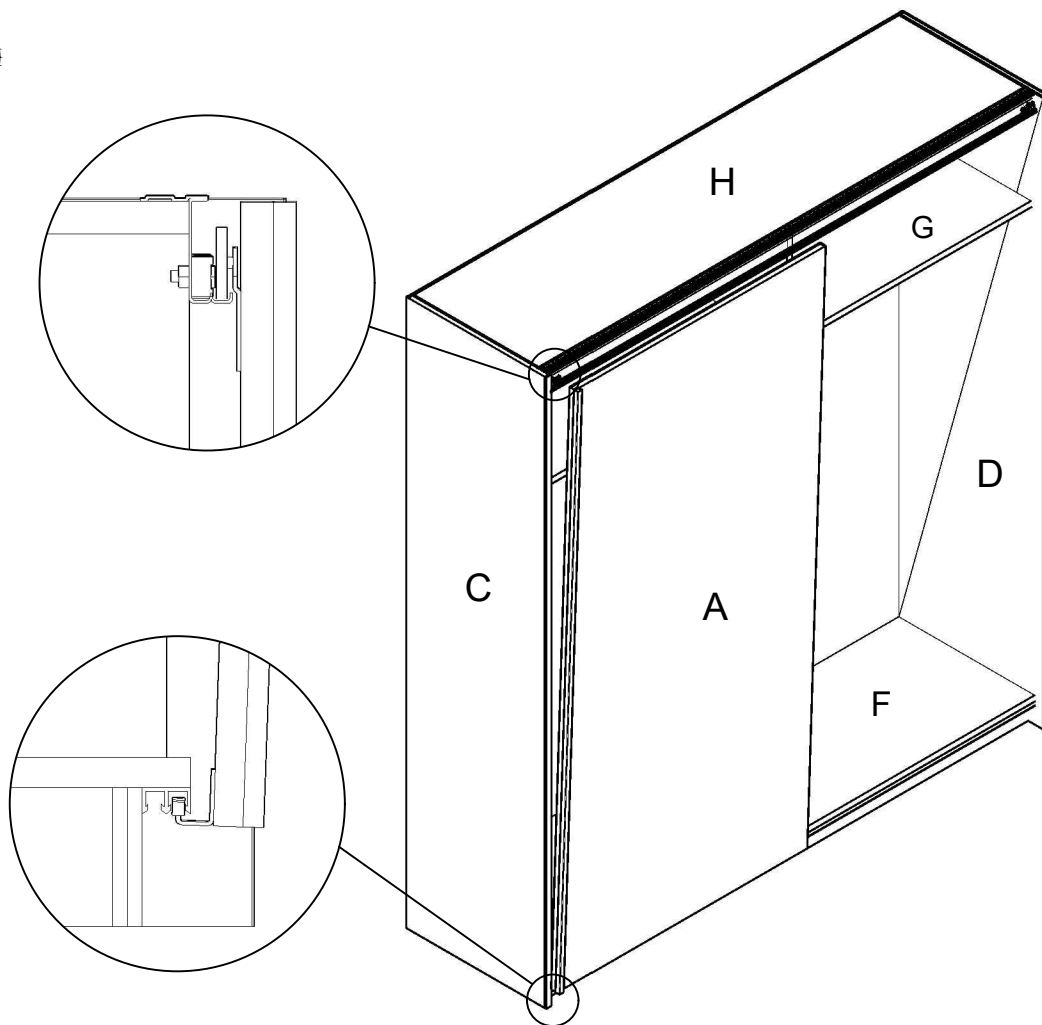

8

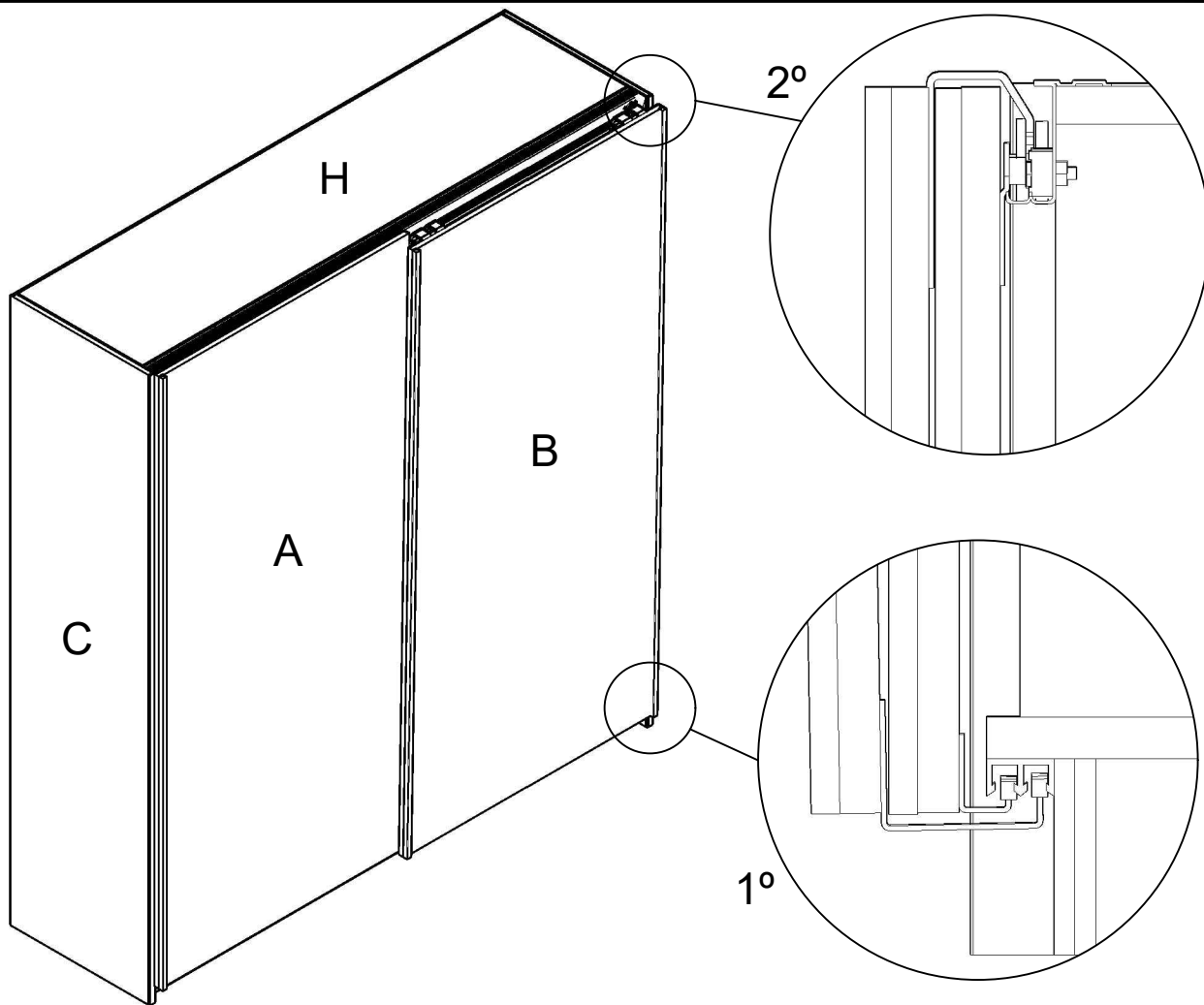

9

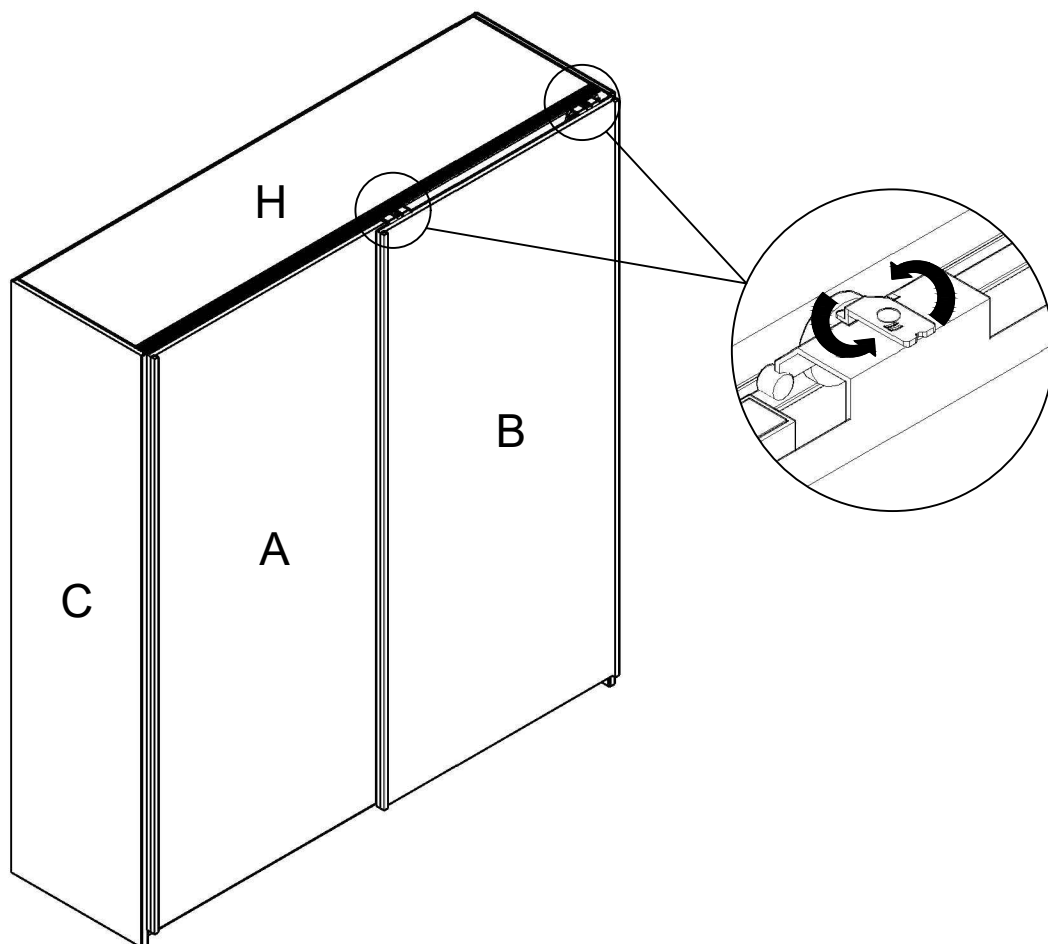

**FRENCH:** "Les meubles contenant des panneaux à base de bois (panneaux de particules, panneaux de fibres, contreplaqué...) peuvent émettre des substances polluantes dans l'air intérieur. Il est ainsi recommandé, après l'installation du meuble dans son logement, d'aérer fréquemment la pièce concernée pendant au moins quatre semaines afin de réduire son exposition aux polluants émis par le meuble."

**SPANISH:** Los muebles que contienen paneles a base de madera (Aglomerado, cartón, contrachapado ...) pueden emitir sustancias contaminantes en el aire. Por lo tanto, se recomienda airear frecuentemente los muebles al menos durante cuatro semanas después de su instalación para reducir su exposición a los contaminantes emitidos por los muebles.

**ENGLISH:** Furniture containing wood-based panels (Particle board, fibreboard, plywood ...) could emit pollutants on the air. Therefore, it is advisable to ventilate the furniture at least during four weeks after its assembly in order to reduce the exposure to the pollutants released by the furniture.

## FRANCAIS - SUISSE

### CONSEILS DE MONTAGE :

- 1 > BIEN ETUDIER LA NOTICE DE MONTAGE.
- 2 > REPEREZ LES PIECES CONSTITUANT VOTRE MEUBLE.
- 3 > REGROUPEZ ET CONTROLEZ LA QUINCAILLERIE.
- 4 > MUNISSEZ-VOUS DE L'OUTILLAGE NECESSAIRE.
- 5 > AMENAGEZ-VOUS UNE ZONE DE MONTAGE.
- 6 > PROCEDEZ AU MONTAGE.



**NE JAMAIS FORCER LES ASSEMBLAGES.  
RESSERREZ LES VIS APRES QUELQUES TEMPS D'USAGE.  
GARDER VOTRE NOTICE DE MONTAGE, SI UNE PIECE  
VENAIT A MANQUER, ELLE SERAIT LE PLUS CLAIR  
MOYEN DE COMMUNIQUER AVEC VOTRE MAGASIN.**

### CONSEILS D'ENTRETIEN :

- 1 > DÉPOUSSIÉREZ SOIGNEUSEMENT.
- 2 > UTILISEZ UN CHIFFON SEC.



**- NE JAMAIS UTILISER  
DE PRODUITS ABRASIFS:  
POUDRE, LAINE D'ACIER, SOLVANTS.  
- NE PAS MOUILLER**

	PAPIER DECOR	SURFACES STRATIFIÉES	SURFACES LAQUÉES	BOIS VERNIS	TEXTILE CUIR
EAU SAVONNEUSE (SAVON NEUTRE)	○	○	○	○	○
EAU ADDITIO NÉE		○	○		
ENTRETIEN SPÉCIFIQUE FABRICANT					○

## DEUTSCH - SCHWEIZ

### MONTAGE ANLEITUNG:

- 1 > DIE MONTAGEANLEITUNG SORGFÄLTIG DURCHLESEN.
- 2 > DIE EINZELTEILE DES MÖBELSTÜCKS ERMITTELN.
- 3 > DIE BESCHLÄGE ZUSAMMENLEGEN UND PRÜFEN.
- 4 > DAS NOTWENDIGE WERKZEUG ZURECHTLEGEN.
- 5 > EINEN MONTAGEBEREICH FREIMACHEN.
- 6 > DAS MÖBELSTÜCK ZUSAMMENBAUEN.



**NIEMALS DIE VERBINDUNGEN ZU STARK ANZIEHEN.  
DIE SCHRAUBEN NACH EINIGER ZEIT DES GEBRAUCHS  
ERNEUT FESTZIEHEN. DIE MONTAGEANLEITUNG  
GUT AUFBEWAHREN: SOLLTE EIN TEIL FEHLEN, IST SIE DAS  
BESTE VERSTÄNDIGUNGSMITTEL MIT IHREM GESCHÄFT.**

### PFLEGEHINWEISE :

- 1 > SORGFÄLTIG ENTSTAUBEN.
- 2 > VERWENDEN SIE EIN TROCKENES TUCH.



**- BENUTZEN SIE KEINE  
SCHEUERMITTEL WIE PULVER,  
STAHLWOLLE, LÖSUNGSMITTEL.  
- KEIN WASSER VERWENDEN.**

	DEKORPAPIER	OBERFLÄCHE LAMINAT	OBERFLÄCHE LACK	LACKIERTEM HOLZ	TEXUL LEDER
SEIFENLAUGE (NEUTRALSEIFE)	○	○	○	○	○
WASSER MIT HAUSHALTSRFINIGER		○	○		
PRODUZENT SPEZIFISCHER UNTERHALT					○

## ITALIANO - SVIZZERA

### CONSIGLI DI MONTAGGIO

- 1 > STUDIARE BENE LE ISTRUZIONI DI MONTAGGIO.
- 2 > PRENDERE CONOSCENZA DEI PEZZI CHE COSTITUISCONO IL MOBILE.
- 3 > RAGGRUPPARE E CONTROLLARE LA FERRAMENTA.
- 4 > MUNIRSI DEGLI UTENSILI NECESSARI.
- 5 > PREPARARE UNA ZONA DI MONTAGGIO.
- 6 > PROCEDERE AL MONTAGGIO.



**NON FORZARE MAI GLI ASSEMBLAGGI  
RISTRINGERE LE VITI DOPO UN PERIODO D'USO  
CONSERVARE QUESTE ISTRUZIONI DI MONTAGGIO,  
SE UN PEZZO VENISSE A MANCARE SAREBBE IL MIGLIORE  
MEZZO DI COMUNICAZIONE CON IL RIVENDITORE**

### CONSIGLI PER LA MANUTENZIONE :

- 1 > SPOLVERATE ACCURATAMENLE.
- 2 > USARE UN PANNINO ASCIUTTO.



**- NON UTILIZZARE MAI PRODOTTI  
ABRASIVI: POLVERE,  
LANA DI ACCIAIO, SOLVENTI.  
- NON BAGNARE.**

	CARTA	SUPERFICIE STRATIFICATE	SUPERFICIE LACCATE	LACCATE EGNO VERNICIATO	TESSILE CUOIO
ACQUA CON SAPONE (SAPONE NEUTRO)	○	○	○	○	○
ACQUA CON DETERSIVO SAN MARC		○	○		
MANUTENZIONE SPECIFICA PRODUTTORE					○

## PORTUGUÊS

### CONSELHOS DE MONTAGEM:

- 1 > ESTUDE BEM AS INSTRUÇÕES DE MONTAGEM.
- 2 > REUNA AS PEÇAS QUE CONSTITUEM O SEU MÓVEL.
- 3 > REAGRUPE AS FERRAGENS.
- 4 > EQUIPE-SE COM AS FERRAMENTAS NECESSÁRIAS.
- 5 > PREPARE UMA ÁREA PARA A MONTAGEM.
- 6 > INICIE A MONTAGEM.



**NUNCA FORÇAR OS ENCAIXES.  
REAPERTAR OS PARAFUSOS APÓS UM TEMPO DE UTILIZAÇÃO.  
GUARDAR AS INSTRUÇÕES DE MONTAGEM.  
CASO FALTE ALGUMA PEÇA, O MAIS ACONSELHÁVEL  
É CONTATAR O REVENDEDOR.**

### CONSELHOS PARA A MANUTENÇÃO :

- 1 > ELIMINAR BEM O PÓ.
- 2 > USAR PANO SECO.



**- NUNCA UTILIZAR PRODUTOS  
ABRASIVOS: SAPONÁCEOS,  
LÃ DE AÇO, SOLVENTES.  
- NÃO MOLHAR .**

	ACABAMENTO IMITAÇÃO	SUPERFÍCIES ESTRATIFICADAS	SUPERFÍCIES LACADAS	MADEIRA ENVERNIZADA	TEXTEIS PELES
ÁGUA COM SABÃO (SABÃO NEUTRO)	○	○	○	○	○
ÁGUA COM DETERGENTE		○	○		
INSTRUÇÕES ESPECÍFICAS DO FABRICANTE					○

## ESPAÑOL

### CONSEJOS PARA EL MONTAJE:

- 1 > ESTUDIE ATENTAMENTE EL MANUAL DE MONTAJE.
- 2 > LOCALICE LAS PIEZAS QUE CONSTITUYEN SU MUEBLE.
- 3 > REUNA Y CONTROLE LOS TORNILLOS.
- 4 > EQUIPE-SE DE LAS HERRAMIENTAS NECESARIAS.
- 5 > PREPARE UNA ZONA DE MONTAJE.
- 6 > REALICE EL MONTAJE.



**NO FUERCE NUNCA EN LAS UNIONES. APRIETE LOS  
TORNILLOS DESPUES DE CIERTO TIEMPO DE UTILIZACION  
CONSERVE SU MANUAL DE MONTAJE,  
SI FALTARA UNA PIEZA, SERIA LA MANERA  
MAS FACIL DE COMUNICAR CON LA TIENDA.**

### CONSEJOS PARA EL MANTENIMIENTO:

- 1 > DESPOLVOREAR CULDADOSAMENTE.
- 2 > UTILICE UN PAÑO SECO.



**- NO USE NUNCA PRODUCTOS  
ABRASIVOS TALES COMO:  
POLVO DE LIMPIAR,  
LANA DE ACERO, SOLVENTES.  
- NO MOJAR.**

	PAPEL DE DECORACION	SUPERFICIE ESTRATIFICADAS	SUPERFICIE MAQUEADAS	MADERA BARNIZADA	TEXULL CUERO
AGUA Y JABON (JABON NEUTRO)	○	○	○	○	○
AGUA COM DETERGENTE		○	○		
MANTENIMIENTO ESPECIFICO DEL FABRICANTE					○

## HRVATSKA

### UPUTE ZA MONTAŽU:

- 1 > PAŽLJIVO PROČITAJTE UPUTE ZA MONTAŽU.
- 2 > PRIPREMITE SVE DIJELOVE NAMJEŠTAJA.
- 3 > PRIKUPITE I PROVJERITE OKOVE ZA MONTAŽU.
- 4 > PRIPREMITE POTREBAN ALAT.
- 5 > PRIPREMITE PROSTOR ZA MONTAŽU.
- 6 > POČNITE MONTIRATI.



**NEMOJTE UPOTREBLJAVATI SILU PRILIKOM SKLAPANJA  
NAKON NEKOG VREMENA PONOVRNO PRITEGNITE VIJKE  
ČUVAJTE UPUTE ZA MONTAŽU  
U SLUČAJU NEDOSTATKA NEKOG DIJELA NAJBOLJE ĆE BITI DA  
DA KONTAKIRATE PRODAJNO MJESTO.**

### UPUTE ZA ODRŽAVANJE :

- 1 > PAŽLJIVO OBRISATI PRAŠINU.
- 2 > KORISTITE SUHU KRPU.



**- ZABRANJENA JE UPOTREBA  
KEMIKALIJA ILI BILO KAKVIH  
POMOĆNIH SREDSTAVA ZA RIBANJE  
JAKIH SREDSTAV ZA ČIŠĆENJE ILI  
ČELIČNE VUNE  
-NE MOKRA.**

	PAPIR	LAMINAT	LAK	DRVO	TEKSTIL/ KOŽA
OTPINA SAPUNA	○	○	○	○	○
OTPINA DETERDŽENTA		○	○		
NAMJENSKA SREDSTVA					○

## TÜRÇE

### MONTAJ TALIMATLARI:

- 1 > MONTAJ TANITIM YAZISINI DIKKATLİCE OKUYUNUZ .
- 2 > MOBİLİYANIZI OLUŞTURAN PARÇALARI İŞARETLEYİNİZ.
- 3 > HIRDAVATLA İLGİLİ PARÇALARI BİR ARAYA TOPLAYIP; KONTROL EDİNİZ.
- 4 > GEREKEN ARAÇ VE GEREĞİ TEDARİK EDİNİZ.
- 5 > (KENDİNİZE) BİR MONTAJ ALANI EDİNİNİZ.
- 6 > MONTE ETMEYE BAŞLAYINIZ.

**MONTAJLARI ZORLAMAYINIZ.**  
**BİRKAÇ KULLANIMDAN SONRA VIDALARI SIKIŞTIRINIZ.**  
**BİR PARÇANIN KAYBOLMASI DURUMUNDA MAGAZANIZLADAKİ KOLAY İLETİŞİME GEÇEBİLMENİZ İÇİN MONTAJ KULLANIM TALİMATİNİZİ SAKLAYINIZ.**

### BAKIM TALIMATLARI:

- 1 > TOZUNU DIKKATLİCE ALINIZ.
- 2 > YUMUŞAK BİR BEZİ TEMİZ SU VE AZ MİKTARDA SABUNLA (DETERJAN) NEMLENDİRİNİZ.

**ASLA AŞINDIRICI ÜRÜNLER KULLANMAYINIZ : ÇELİK YÜNÜ, SOLVENT... BOL SUYLA YIKAMAYINIZ.**

	SÜS KAGIDI	KATMAN YÜZEY	LAKE YÜZEY	CILALI TAHTA	TEKSTİL DERİ
SABUNLU SU (NOTR SABUN)	○	○	○	○	○
DETERJAN KATILMIŞ SU		○	○		
ÜRETİCİYE ÖZGÜ BAKIM					○

## ENGLISH

### ASSEMBLY ADVICE :

- 1 > CAREFULLY READ THE ASSEMBLY INSTRUCTION.
- 2 > IDENTIFY THE COMPONENTS OF THE FURNITURE.
- 3 > GROUP AND CHECK THE HARDWARE.
- 4 > USE THE REQUIRED TOOLS.
- 5 > CREATE AN ASSEMBLY ZONE.
- 6 > MAKE THE ASSEMBLY.

**NEVER FORCE THE CONNECTIONS.**  
**RE-TIGHTEN THE SCREWS AFTER FEW DAYS.**  
**PLEASE RETAIN THE AI LEAFLET FOR FUTURE REFERENCE, THE AI CONTAINS INFORMATION WHEN CLAIMING FOR MISSING PARTS.**

### CLEANING ADVICE:

- 1 > CAREFULLY REMOVE THE DUST.
- 2 > USE A SOFT, CLEAN DAMP CLOTH WITH SOAPY WATER.

**NEVER USE ABRASIVE PRODUCTS OR SOLVENTS.**  
**DO NOT APPLY EXCESSIVE PRESSURE WHEN USING THE DAMP CLOTH.**

	PAPER DECOR	LAMINATED SURFACES	LACQUERED SURFACE	VARNISHED WOOD	LEATHER TEXTILE
SOAPY WATER (NEUTRAL SOAP)	○	○	○	○	○
WATER WITH DETERGENT		○	○		
SPECIFIC SUPPLIER CLEANING					○

**PENSEZ AU TRI !**  
**ENSEMBLE RÉDUISONS L'IMPACT ENVIRONNEMENTAL DES EMBALLAGES**

**ÉLÉMENT(S) PLASTIQUE(S)**



**À JETER**

**ÉLÉMENT(S) MÉTAL(S) CARTON(S) PAPIER(S)**



**À RECYCLER**



CONSIGNE POUVANT VARIER LOCALEMENT > [WWW.CONSIGNESDETRI.FR](http://WWW.CONSIGNESDETRI.FR)