

# TAMIRA

APARADOR TAMIRA 4P 160CM  
SIDEBOARD TAMIRA 4D 160CM  
BUFFET TAMIRA 4P 160CM

Instrucciones de Montaje  
Assembly Instructions  
Notice de Montage  
Istruzioni di Montaggio  
Instruções de Montagem  
Montageanleitung

*Version 28/10/2025*

**19516** EAN Code: **8435178348227**

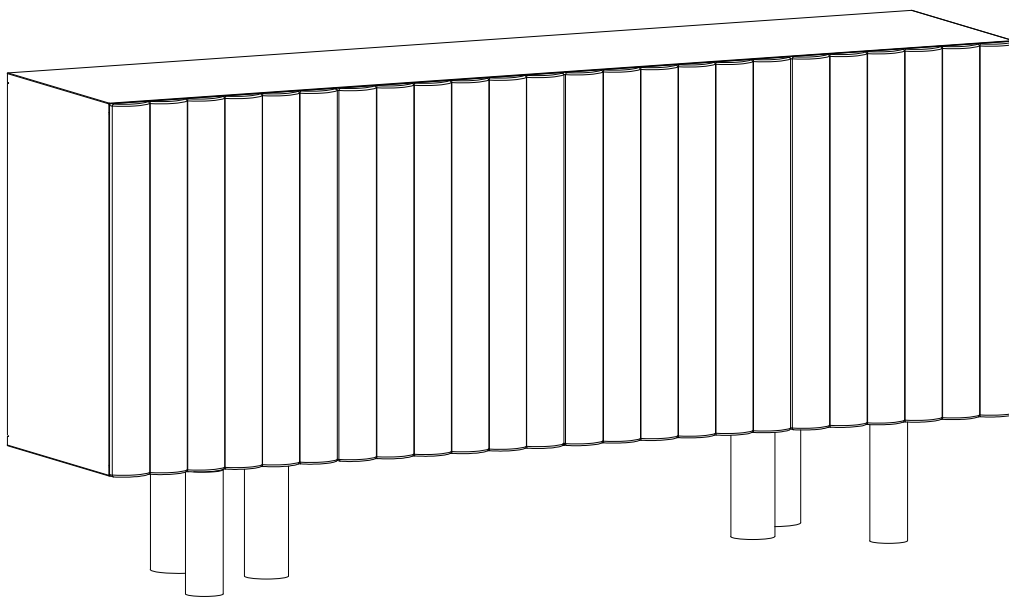

MARCKERIC S.L.  
c/ Enlace Verola S/N  
46430 Sollana - Valencia (SPAIN)  
ventas@marckeric.com

**mome**



- ES:** → **IMPORTANTE:** Antes de empezar, este mueble requiere montaje. Lea atentamente las instrucciones de montaje y consérvelas para futuras consultas.
- Este mueble es para uso doméstico
  - Compruebe que tiene toda la tornillería y todas las piezas antes de empezar el montaje.
  - No monte ni utilice el mueble si hubiera piezas rotas o dañadas o si faltaran piezas, y emplee únicamente piezas aprobadas por el fabricante.
  - Apriete firmemente las fijaciones y emplee únicamente las herramientas suministradas o recomendadas.
  - El montaje, el apuntalamiento o la manipulación incorrectos podrían debilitar el ensamblado de las piezas.
  - Mantenga a los niños alejados durante el montaje. El producto contiene piezas pequeñas que podrían ingerirse.
  - Todas las uniones deberán apretarse adecuadamente y verificarse periódicamente, volviéndolas a apretar si fuera necesario.
  - No desplace un mueble que esté cargado.
  - El mueble no está diseñado para volverse a montar.

- EN:** → **IMPORTANT:** Before starting, this furniture self-assembly required. Please read the assembly instructions carefully and keep them for future reference.
- This furniture is for domestic use.
  - Check that all of the hardware and parts are present and in good condition before starting assembly.
  - Do not assemble or use the furniture if any of the parts are broken, damaged or missing, and only use parts approved by the manufacturer.
  - Firmly tighten the fasteners and use only the tools supplied or recommended.
  - Improper assembly, cribbing or handling can lead to assemblies and/or parts becoming weakened.
  - Keep young children away during assembly. The product contains small parts that could be ingested.
  - All joints should always be properly tightened and regularly checked, and retightened, if necessary.
  - Do not move furniture that is loaded.
  - Furniture is not intended to be reassembled.

- FR:** → **IMPORTANT:** Avant de commencer, ce meuble a monter soi-même. Lisez attentivement les notices de montage et conservez-les pour référence ultérieure.
- Ce meuble est à usage domestique.
  - Vérifier la présence et l'état de la quincaillerie et des pièces avant de débiter le montage.
  - Ne pas monter ou utiliser le mobilier si certains éléments sont cassés, endommagés ou manquants, et n'utiliser que des pièces approuvées par le fabricant.
  - Serrez fermement les fixations et utilisez uniquement les outils fournis ou recommandés.
  - Un mauvais montage, calage ou manutention incorrects pourraient affaiblir l'assemblage des pièces.
  - Tenir éloigné les jeunes enfants lors de l'assemblage. Présence de petites pièces susceptibles d'être ingérées.
  - Il convient que tous les dispositifs d'assemblage soient toujours convenablement serrés et régulièrement vérifiés, et resserrés, si nécessaire.
  - Ne pas déplacer un mobilier chargé.
  - Mobilier non prévu pour être remonté.



- IT:** → **IMPORTANTE:** Prima di cominciare, questo mobile richiede da assemblare. Leggere attentamente le istruzioni di montaggio e conservarle per riferimenti futuri.
- Questo mobile è destinato all'uso domestico.
  - Verificare la presenza e lo stato dei dispositivi di fissaggio e dei componenti prima di iniziare il montaggio.
  - Non montare né utilizzare il mobile se ci sono pezzi rotti, danneggiati o mancanti. Utilizzare solo componenti approvati dal produttore.
  - Serrare saldamente i dispositivi di fissaggio e utilizzare solo gli utensili forniti o raccomandati.
  - Un montaggio, rinforzo o manipolazione scorretti possono indebolire la struttura.
  - Tenere i bambini lontani durante il montaggio. Il prodotto contiene piccole parti che potrebbero essere ingerite.
  - Si raccomanda di verificare regolarmente il corretto serraggio dei dispositivi di assemblaggio; serrarli se necessario.
  - Non spostare un mobile carico.
  - Il mobile non è progettato per essere smontato e rimontato.
- PT:** → **IMPORTANTE:** Antes de começar, este móvel requer montagem. Leia atentamente as instruções e guarde-as para futuras consultas.
- Este móvel é para uso doméstico.
  - Verifique se possui todos os parafusos e peças antes de iniciar a montagem.
  - Não monte nem utilize o móvel se houver peças partidas, danificadas ou em falta. Utilize apenas peças aprovadas pelo fabricante.
  - Aperte bem todas as fixações e utilize apenas as ferramentas fornecidas ou recomendadas.
  - Montagem, reforço ou manuseio incorretos podem enfraquecer a estrutura.
  - Mantenha as crianças afastadas durante a montagem. O produto contém peças pequenas que podem ser ingeridas.
  - Todas as uniões devem ser apertadas adequadamente e verificadas periodicamente, reapertando-as se necessário.
  - Não mova o móvel quando estiver carregado.
  - O móvel não foi projetado para ser remontado.
- DE:** → **WICHTIG:** Vor dem Beginn muss dieses Möbelstück montiert werden. Lesen Sie die Montageanleitung sorgfältig durch und bewahren Sie sie für spätere Nachschlagezwecke auf.
- Dieses Möbel ist für den Hausgebrauch bestimmt.
  - Überprüfen Sie, ob alle Schrauben und Teile vorhanden sind, bevor Sie mit der Montage beginnen.
  - Montieren oder benutzen Sie das Möbel nicht, wenn Teile beschädigt, defekt oder fehlend sind. Verwenden Sie nur vom Hersteller zugelassene Teile.
  - Ziehen Sie alle Befestigungen fest an und verwenden Sie nur die mitgelieferten oder empfohlenen Werkzeuge.
  - Eine unsachgemäße Montage, Abstützung oder Handhabung kann die Stabilität beeinträchtigen.
  - Halten Sie Kinder während der Montage fern. Das Produkt enthält Kleinteile, die verschluckt werden könnten.
  - Alle Verbindungen müssen fest angezogen und regelmäßig überprüft und bei Bedarf nachgezogen werden.
  - Bewegen Sie keine Möbelstücke, die beladen sind.
  - Das Möbelstück ist nicht für eine erneute Demontage und Montage vorgesehen.



**ES:** → El montaje requiere de dos personas.  
→ Verifique las herramientas necesarias para el montaje. Las herramientas no están incluidas.  
→ No utilizar herramientas eléctricas.

**EN:** → Assembly requires two people.  
→ Check which tools are needed for assembly. Tools are not included.  
→ Do not use power tools.

**FR:** → Le montage nécessite deux personnes.  
→ Vérifiez quels outils sont nécessaires pour le montage. Les outils ne sont pas inclus.  
→ N'utilisez pas d'outils électriques.

**IT:** → Il montaggio richiede due persone.  
→ Verificare quali strumenti sono necessari per il montaggio. Gli strumenti non sono inclusi.  
→ Non utilizzare utensili elettrici.

**PT:** → A montagem requer duas pessoas.  
→ Verifique quais ferramentas são necessárias para a montagem. As ferramentas não estão incluídas.  
→ Não utilize ferramentas elétricas.

**DE:** → Für die Montage werden zwei Personen benötigt.  
→ Prüfen Sie, welche Werkzeuge für die Montage erforderlich sind. Werkzeuge sind nicht im Lieferumfang enthalten.  
→ Keine Elektrowerkzeuge verwenden.



**ES:** **Composición del producto**  
Madera mango

**EN:** **Product Composition**  
Mango wood

**FR:** **Composition du produit**  
Madeira de manga

**IT:** **Composizione del prodotto**  
Legno di mango

**PT:** **Composição do produto**  
Bois de manguier

**DE:** **Produktzusammensetzung**  
Mangoholz



**ES:** Después de montar este producto, es aconsejable ventilar la habitación frecuentemente, durante algunos días.

**EN:** After assembling this product, it is recommended to regularly ventilate the room for a few days.

**FR:** Après assemblage de ce produit, il est conseillé d'aérer régulièrement la pièce pendant quelques jours.

**IT:** Dopo aver montato il prodotto si consiglia di ventilare la stanza per alcuni giorni.

**PT:** Depois de montar este produto, é aconselhável ventilar o ambiente com frequência, durante alguns dias.

**DE:** Nach dem Aufbau dieses Produkts wird empfohlen, den Raum für einige Tage regelmäßig zu lüften.



1PC / 1CTNS

Caja Box Colis	Tamaño de la caja Box dimensions Dimensions colis	Peso neto Net weight Podis net	Peso bruto Gross weight Podis brut
1/1	1700x510x710 mm	51.56 kg	61.6 kg



ES: Peso máximo recomendado.  
EN: Maximum weight recommended.  
FR: Poids maximum recommand



01

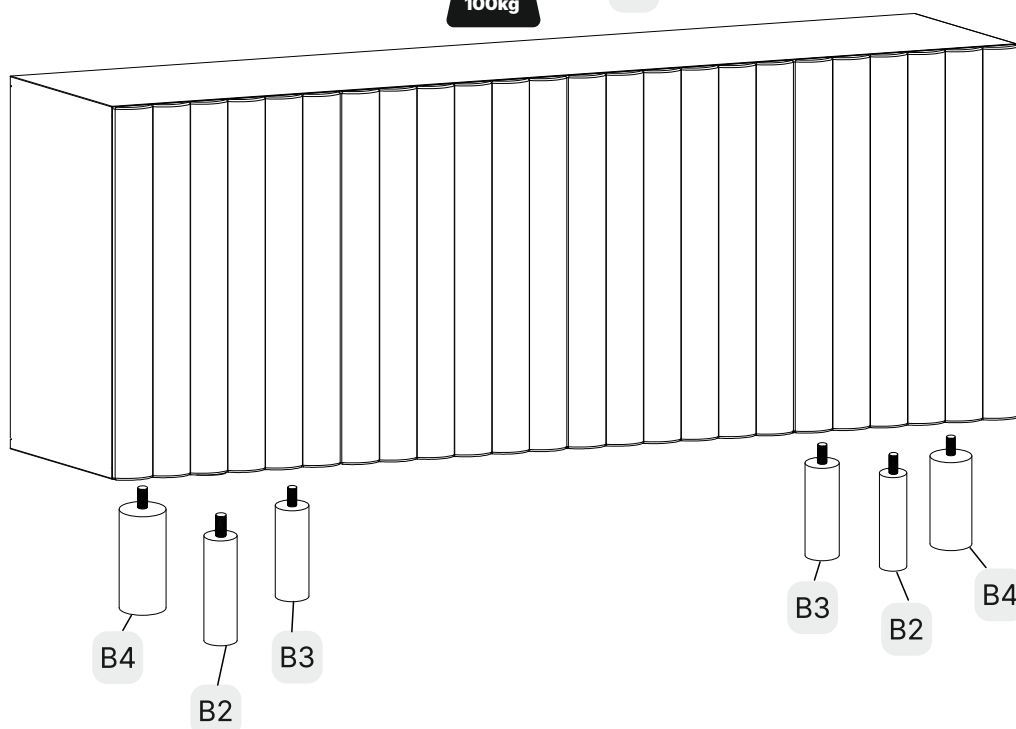

### Caja-Box-Colis 1/1

Piece 01 x 1 un.  
Piece B2 x 2 un.  
Piece B3 x 2 un.  
Piece B4 x 2 un.

Herrajes	Hoja de montaje
Hardware	Assembly sheet
Quincaillerie	Notice de montage

# Medidas - Measures - Mesures

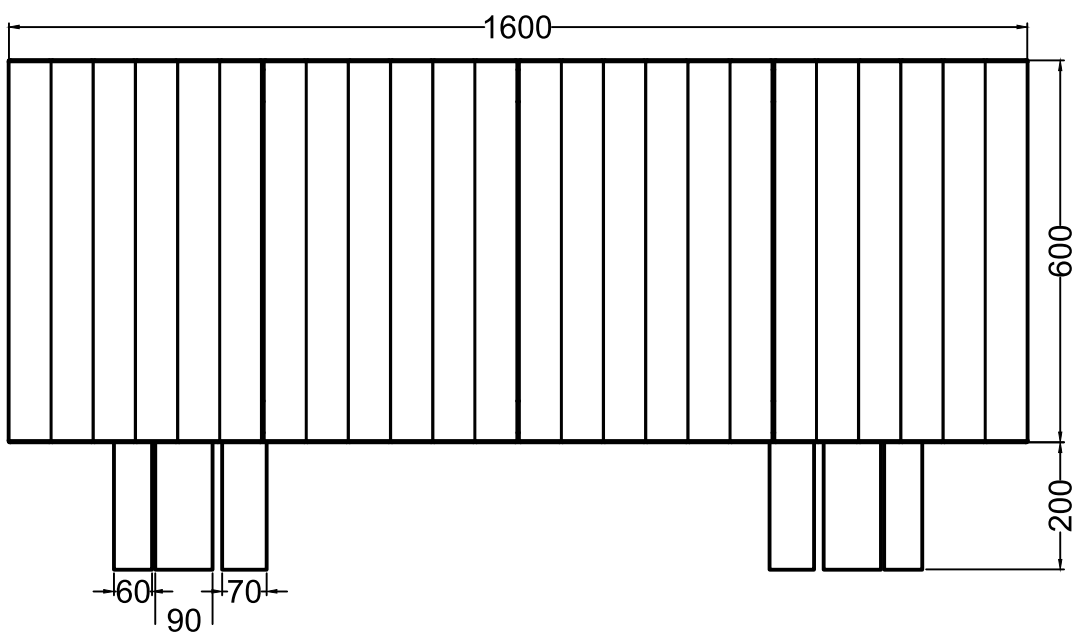
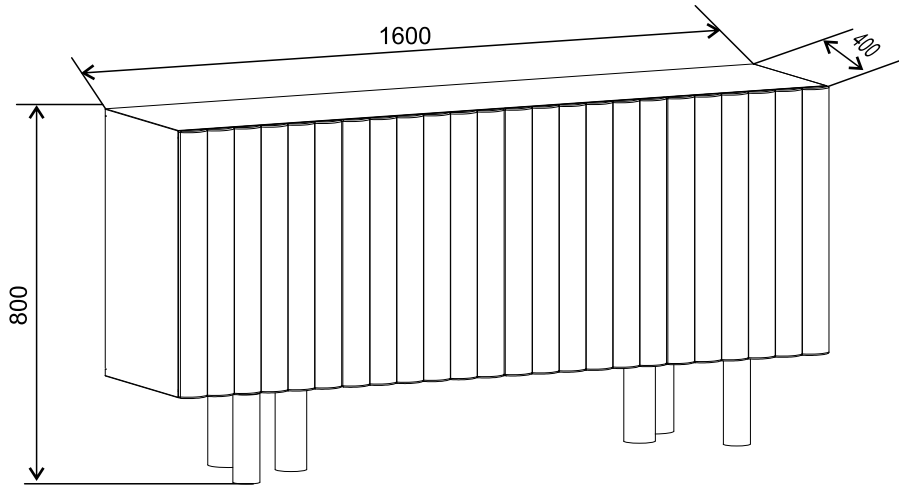

Listado de piezas - Parts list - Composants

01

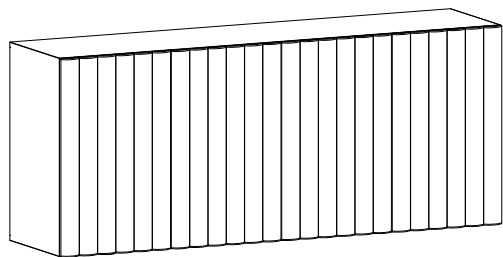

1 un.

B2



2 un.

B3



2 un.

B4



2 un.

1



**ES:** Utilice una manta para evitar daños al mueble.

**EN:** Use a cover to avoid damage the furniture.

**FR:** Utilisation d'une couverture recommandée pour ne pas abimer le meuble.

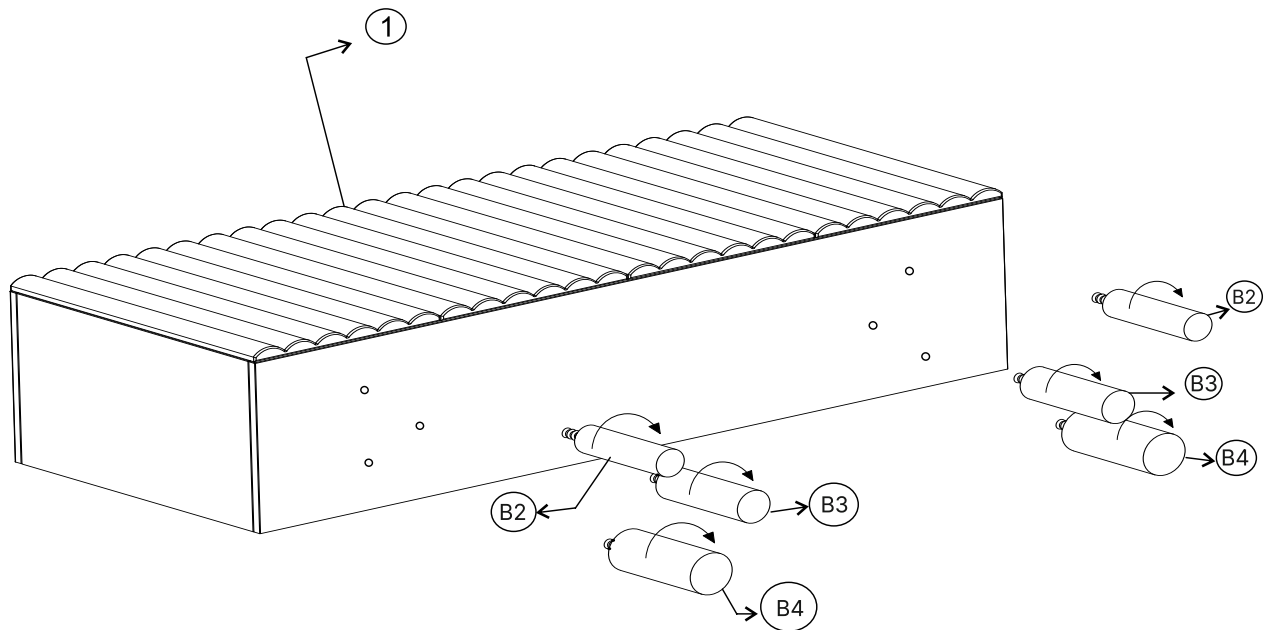

2



**ES:** Girar el mueble con cuidado. Utilice una manta para evitar daños al mueble.

**EN:** Turn the furniture careful. Use a cover to avoid damage the furniture.

**FR:** Basculer le meuble avec précaution. Utilisation d'une couverture recommandée pour ne pas abimer le meuble.

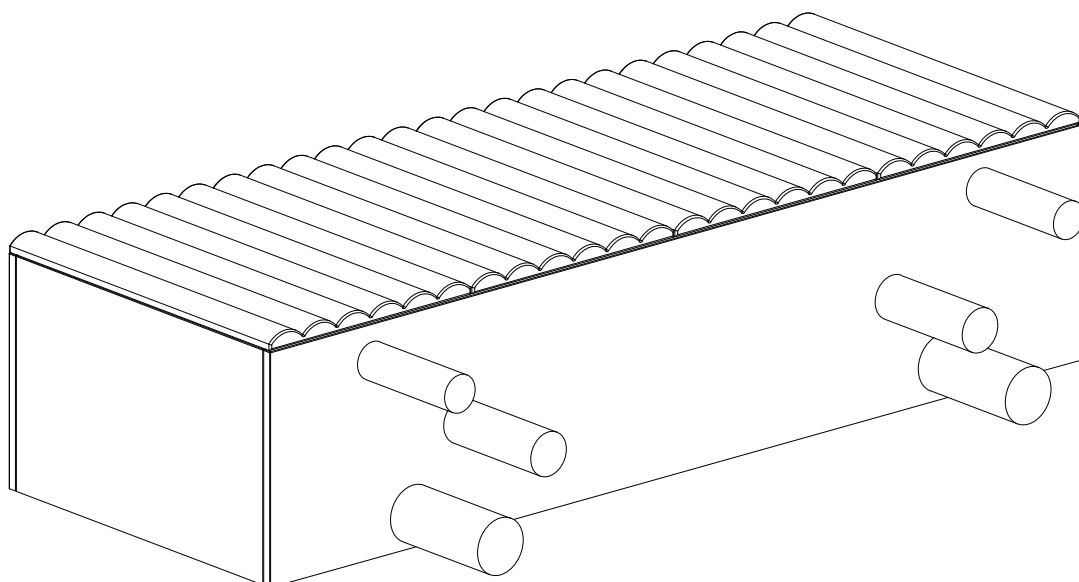

# 3



**ES:** En caso de reclamación, por favor, facilite la información que aparece en la etiqueta ID.

**EN:** If you may have whatever complaint, please, let us know the information written on the ID label

**FR:** En cas de réclamation, merci de transmettre les informations contenues sur l'étiquette fixée sur le produit.

## ID Label

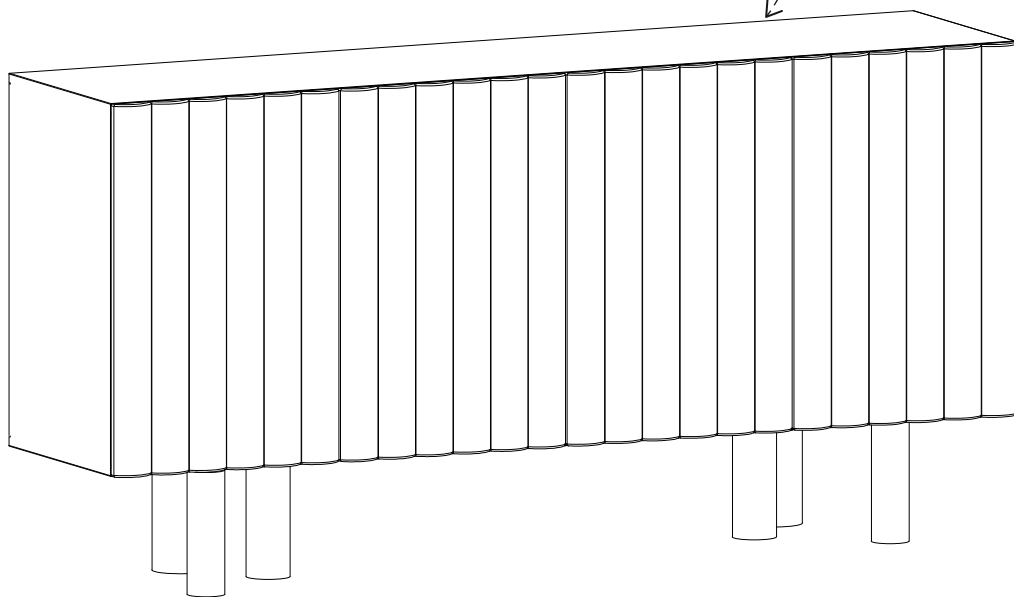

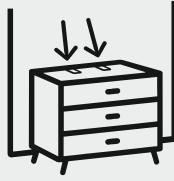

**ES: IMPORTANTE: OBLIGATORIO FIJAR A LA PARED.**

→ Para evitar el vuelco accidental de los muebles, es obligatorio fijarlos en la pared. El tipo de tornillos necesarios para fijar el mueble a la pared, dependen del material de la pared, no se suministran. En caso de duda, consulte a un especialista.

→ Utilice los tornillos y tacos adecuados para su muro. Existe una gran diversidad de muros y paredes, por esta razón no podemos proporcionarle el herraje adecuado para su pared.

→ Primero es necesario identificar el tipo de pared para luego utilizar el herraje adecuado. En caso de duda, dirijase a una tienda especializada para más información.

**FR: IMPORTANT: FIXATION MURALE OBLIGATOIRE.**

→ Pour éviter le basculement accidentel du meuble, la fixation du meuble au mur est obligatoire. La visserie nécessaire pour la jonction mur/meuble, dépendante de la nature du mur, n'est pas fournie. En cas de doute, consulter un spécialiste.

→ Utilisez des vis et des chevilles adaptées à vos murs. Il existe une grande diversité de types de murs ou cloisons, c'est la raison pour laquelle nous ne pouvons vous fournir une quincaillerie adaptée à votre mur.

→ Il est nécessaire d'identifier le type de paroi à laquelle vous allez fixer ce produit afin de vous procurer les fixations appropriées. En cas de besoin, adressez vous à un magasin spécialisé pour conseil.

**PT: IMPORTANTE: OBRIGATÓRIO FIXAR NA PAREDE.**

→ Para evitar o tombamento acidental dos móveis, é obrigatório fixá-los na parede. O tipo de parafusos necessários para fixar o móvel à parede depende do material da parede e não está incluído. Em caso de dúvida, consulte um especialista.

→ Utilize os parafusos e buchas adequados para sua parede. Existe uma grande variedade de paredes e, por isso, não podemos fornecer a fixação adequada para o seu caso.

→ Primeiro é necessário identificar o tipo de parede para depois usar a fixação correta. Em caso de dúvida, dirija-se a uma loja especializada para mais informações.

**EN: IMPORTANT: OBLIGATORY FIX ON THE WALL.**

→ To avoid the accidental tip-over of the furniture, the fixing of the furniture on the wall is mandatory. The needed hardware for the junction wall/furniture, depending of the nature of the wall, is not provided. If any doubt, consult a specialist.

→ Use screws and plugs suitable for your wall. Due to the wide diversity of wall or partition types, we cannot provide you with suitable attachment fixtures.

→ To determine which attachment fixtures to use, you will need to identify the type of wall to which you will be fixing this product. If you have whatever doubt, please, go to one specialised shop for further information.

**IT: IMPORTANTE: FISSAGGIO OBBLIGATORIO ALLA PARETE.**

→ Per evitare il ribaltamento accidentale del mobile è obbligatorio il fissaggio a muro. I tasselli necessari per il collegamento mobile\muro, dipendenti dal tipo di muro, non sono provvisti. Consultare uno specialista in caso di dubbi.

→ Utilizzare viti e tasselli adatti alla propria parete. Le pareti sono molto diverse tra loro, quindi non possiamo fornirvi la ferramenta giusta per la vostra parete.

→ Prima di tutto è necessario identificare il tipo di parete e poi utilizzare la ferramenta corretta. In caso di dubbio, contattate un rivenditore specializzato per maggiori informazioni.

**DE: WICHTIG: MÖBEL MÜSSEN AN DER WAND BEFESTIGT WERDEN.**

→ Um ein versehentliches Umkippen der Möbel zu verhindern, müssen diese an der Wand befestigt werden. Die Art der Schrauben, die zur Befestigung benötigt werden, hängt vom Wandmaterial ab und ist nicht im Lieferumfang enthalten. Im Zweifelsfall wenden Sie sich an einen Fachmann.

→ Verwenden Sie geeignete Schrauben und Dübel für Ihre Wand. Es gibt viele verschiedene Wandtypen, daher können wir keine universelle Befestigungslösung anbieten.

→ Zuerst muss der Wandtyp bestimmt werden, um dann das passende Befestigungsmaterial zu verwenden. Bei Fragen wenden Sie sich bitte an ein Fachgeschäft.



**ES:** Debido a la gran diversidad de tipos de muros o tabiques, no podemos proporcionarle los herrajes de fijación adecuados. Para determinar qué tipo de fijación utilizar, deberá identificar el tipo de pared en la que va a instalar este producto. A continuación, se presentan algunos ejemplos de fijaciones recomendadas para:

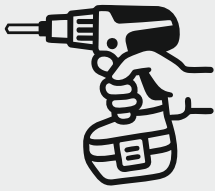

MUROS MACIZOS		PAREDES HUECAS		
Taco de nylon "FISCHER"	Taco metálico	Taco con aletas de nylon	Taco metálico de expansión	Taco tipo "MOLLY"

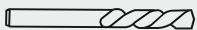

Utilice una broca compatible en tamaño con los herrajes utilizados y con el tipo de pared.



**EN:** Due to the wide diversity of wall or partition types, we cannot provide you with suitable attachment fixtures. To determine which attachment fixtures to use, you will need to identify the type of wall to which you will be fixing this product. Here are some examples of attachment fixtures recommended for:

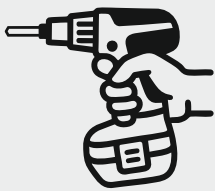

BLIND WALLS		STUDDED WALLS		
"FISCHER" Nylon plug	Metal wall plug	Nylon winged wall plug	Metal expansion plug	"MOLLY" plug

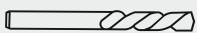

Use a drill bit that is compatible in size with the hardware used and the type of wall.



**FR:** Il existe une grande diversité de types de murs ou cloisons, c'est la raison pour laquelle nous ne pouvons vous fournir le type exact de fixation. Il est nécessaire d'identifier le type de paroi à laquelle vous allez fixer ce produit afin de vous procurer les fixations appropriées. Voici quelques exemples de fixations conseillées pour:

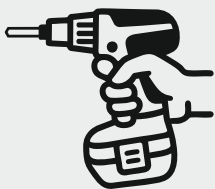

LES MURS PLEINS		LES CLOISONS CREUSES		
Cheville Nylon "FISCHER"	Cheville d'ancrage métal	Cheville d'ancrage à ailettes en Nylon	Cheville métallique à expansion	Cheville "MOLLY"

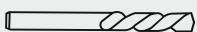

Utiliser une taille de forêt adaptée à la quincaillerie utilisée et au type de mur.



**IT:** Esiste una gran varietà di tipi di muri o paratie e noi siamo in grado di fornirvi il tipo esatto di fissaggio per ognuno di essi. È necessario identificare il tipo di parete alla quale intendete fissare questo prodotto in modo da fornirvi i fissaggi più idonei. Ecco qualche esempio di fissaggi consigliati per:

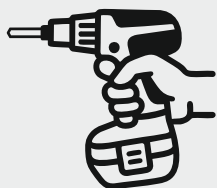

I MURI PIENI		PARATIE CAVE		
Tassello Nylon "FISCHER"	Tassello di ancoraggio in metallo	Tassello di ancoraggio ad alette in Nylon	Tassello metallico ad espansione	Tassello "MOLLY"

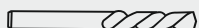

Utilizzare una punta di trapano adatta agli utensili utilizzati e al tipo di muro.



**PT:** Devido à grande variedade de tipos de paredes ou divisórias, não podemos fornecer os acessórios de fixação adequados. Para determinar quais fixadores utilizar, será necessário identificar o tipo de parede onde o produto será instalado. Abaixo, alguns exemplos de fixadores recomendados para:

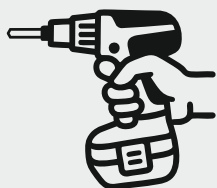

PAREDES MACIÇAS		PAREDES OCAS		
Bucha de Nylon "FISCHER"	Bucha metálica	Bucha de Nylon com abas	Bucha metálica de expansão	Bucha tipo "MOLLY"



Utilize uma broca compatível em tamanho com os fixadores utilizados e com o tipo de parede.



**DE:** Es gibt eine Vielzahl verschiedener Arten von Mauern oder Zwischenwänden, und aus diesem Grunde können wir Ihnen den genau entsprechenden Befestigungstyp nicht bereitstellen. Zunächst ist es erforderlich, die exakte Bauart der Wand zu ermitteln, an der Sie dieses Produkt anbringen werden, um die für diese Wand geeigneten Befestigungsmittel im Fachhandel erwerben zu können. Nachfolgend einige Beispiele empfohlener Befestigungen für:

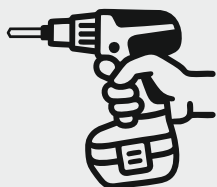

VOLLWÄNDE		HOHLWÄNDE		
Nyldübel "FISCHER"	Ankerdübel aus metall	Ankerdübel mit Nylonflügeln	Spreizdübel für Verankerung aus metall	MOLLY-Dübel



Bitte verwenden Sie eine für die Eisenwaren und den Wandtyp geeignete Bohrergröße.



## Consejos de montaje

1. Lea atentamente las instrucciones de montaje.
2. Identifique los componentes del mueble.
3. Agrupe y revise la tornillería.
4. Use las herramientas necesarias.
5. Prepare una zona de montaje.
6. Monte el mueble.



## Consejos de mantenimiento y limpieza

- Nunca fuerce las uniones.
- Apriete los tornillos después de un tiempo de uso.
- Conserve el manual de montaje; si falta alguna pieza, es la forma más fácil de contactar con la tienda.
- No utilice productos abrasivos, lana de acero ni disolventes.
- No moje el producto.
- Quite cuidadosamente el polvo.
- Utilice un paño ligeramente humedecido.

Instrucciones de mantenimiento
Paño suave ligeramente húmedo
Agua con jabón
Agua con detergente
Esjonja anti-rayaduras
Mantenimiento específico del fabricante

Advertencias
Antes de cualquier mantenimiento, limpie el polvo con cuidado
Cualquier mancha debe limpiarse rápidamente
No utilice productos abrasivos (polvo, lana de acero)
No utilice disolventes
No mojar
No limpiar con hidrolimpiadora (productos de exterior)

Información específica
Consulte la información adicional adjunta al producto.

Materiales												
Madera maciza acelitada	Madera encerada	Madera barnizada o teñida	Panel de madera con papel decorativo	Paneles recubiertos de melamina	Superficie lacada	Piedras	Cuero	Metal	Plástico	Textil	Textil revestido (PU, PVC)	Producto con partes eléctricas

<input type="checkbox"/>	<input type="checkbox"/>	<input type="checkbox"/>	<input type="checkbox"/>	<input type="checkbox"/>	<input type="checkbox"/>	<input type="checkbox"/>	<input type="checkbox"/>	<input type="checkbox"/>	<input type="checkbox"/>	<input type="checkbox"/>	<input type="checkbox"/>	<input type="checkbox"/>
<input type="checkbox"/>	<input type="checkbox"/>	<input type="checkbox"/>	<input type="checkbox"/>	<input type="checkbox"/>	<input type="checkbox"/>	<input type="checkbox"/>	<input type="checkbox"/>	<input type="checkbox"/>	<input type="checkbox"/>	<input type="checkbox"/>	<input type="checkbox"/>	<input type="checkbox"/>
<input type="checkbox"/>	<input type="checkbox"/>	<input type="checkbox"/>	<input type="checkbox"/>	<input type="checkbox"/>	<input type="checkbox"/>	<input type="checkbox"/>	<input type="checkbox"/>	<input type="checkbox"/>	<input type="checkbox"/>	<input type="checkbox"/>	<input type="checkbox"/>	<input type="checkbox"/>
<input type="checkbox"/>	<input type="checkbox"/>	<input type="checkbox"/>	<input type="checkbox"/>	<input type="checkbox"/>	<input type="checkbox"/>	<input type="checkbox"/>	<input type="checkbox"/>	<input type="checkbox"/>	<input type="checkbox"/>	<input type="checkbox"/>	<input type="checkbox"/>	<input type="checkbox"/>

<input type="checkbox"/>	<input type="checkbox"/>	<input type="checkbox"/>	<input type="checkbox"/>	<input type="checkbox"/>	<input type="checkbox"/>	<input type="checkbox"/>	<input type="checkbox"/>	<input type="checkbox"/>	<input type="checkbox"/>	<input type="checkbox"/>	<input type="checkbox"/>	<input type="checkbox"/>
<input type="checkbox"/>	<input type="checkbox"/>	<input type="checkbox"/>	<input type="checkbox"/>	<input type="checkbox"/>	<input type="checkbox"/>	<input type="checkbox"/>	<input type="checkbox"/>	<input type="checkbox"/>	<input type="checkbox"/>	<input type="checkbox"/>	<input type="checkbox"/>	<input type="checkbox"/>
<input type="checkbox"/>	<input type="checkbox"/>	<input type="checkbox"/>	<input type="checkbox"/>	<input type="checkbox"/>	<input type="checkbox"/>	<input type="checkbox"/>	<input type="checkbox"/>	<input type="checkbox"/>	<input type="checkbox"/>	<input type="checkbox"/>	<input type="checkbox"/>	<input type="checkbox"/>
<input type="checkbox"/>	<input type="checkbox"/>	<input type="checkbox"/>	<input type="checkbox"/>	<input type="checkbox"/>	<input type="checkbox"/>	<input type="checkbox"/>	<input type="checkbox"/>	<input type="checkbox"/>	<input type="checkbox"/>	<input type="checkbox"/>	<input type="checkbox"/>	<input type="checkbox"/>
<input type="checkbox"/>	<input type="checkbox"/>	<input type="checkbox"/>	<input type="checkbox"/>	<input type="checkbox"/>	<input type="checkbox"/>	<input type="checkbox"/>	<input type="checkbox"/>	<input type="checkbox"/>	<input type="checkbox"/>	<input type="checkbox"/>	<input type="checkbox"/>	<input type="checkbox"/>

<input type="checkbox"/>	<input type="checkbox"/>	<input type="checkbox"/>	<input type="checkbox"/>	<input type="checkbox"/>	<input type="checkbox"/>	<input type="checkbox"/>	<input type="checkbox"/>	<input type="checkbox"/>	<input type="checkbox"/>	<input type="checkbox"/>	<input type="checkbox"/>	<input type="checkbox"/>
--------------------------	--------------------------	--------------------------	--------------------------	--------------------------	--------------------------	--------------------------	--------------------------	--------------------------	--------------------------	--------------------------	--------------------------	--------------------------



## Assembly advices

1. Carefully read the assembly instruction.
2. Identify the components of the furniture.
3. Group and check the hardware.
4. Use the required tools.
5. Create an assembly zone.
6. Make the assembly.



## Maintenance and cleaning advices

- Never force the connections.
- Tighten the screws after a period of use.
- Keep the assembly manual; if a part is missing, it is the easiest way to contact the store.
- Do not use abrasive powders, steel wool or solvents.
- Do not wet.
- Carefully remove dust.
- Use a slightly damp cloth.

### Maintenance instructions

Slightly damp soft cloth
Soapy water
Water with detergent
Anti-scratch scouring sponge
Manufacturer specific maintenance

### Warning

Before any maintenance, clean the dust carefully
Any stain should be cleaned quickly
Never use an abrasive product (powder, steel wool)
Never use solvent
Do not wet
Do not clean with high pressure cleaner (outdoor products)

### Specific information

Check extra information attached on the product
---

### Materials

Solid wood oiled	Waxed wood	Varnished or stained wood	Wood panel covered with decorative paper	Melamine covered panels	Lacquered surface	Stones	Leather	Metal	Plastic	Textile	Enducted textile (PU, PVC)	Product with electrical parts
<input type="checkbox"/>	<input type="checkbox"/>	<input type="checkbox"/>	<input type="checkbox"/>	<input type="checkbox"/>	<input type="checkbox"/>	<input type="checkbox"/>	<input type="checkbox"/>	<input type="checkbox"/>	<input type="checkbox"/>	<input type="checkbox"/>	<input type="checkbox"/>	<input type="checkbox"/>
<input type="checkbox"/>	<input type="checkbox"/>	<input type="checkbox"/>	<input type="checkbox"/>	<input type="checkbox"/>	<input type="checkbox"/>	<input type="checkbox"/>	<input type="checkbox"/>	<input type="checkbox"/>	<input type="checkbox"/>	<input type="checkbox"/>	<input type="checkbox"/>	<input type="checkbox"/>
<input type="checkbox"/>	<input type="checkbox"/>	<input type="checkbox"/>	<input type="checkbox"/>	<input type="checkbox"/>	<input type="checkbox"/>	<input type="checkbox"/>	<input type="checkbox"/>	<input type="checkbox"/>	<input type="checkbox"/>	<input type="checkbox"/>	<input type="checkbox"/>	<input type="checkbox"/>
<input type="checkbox"/>	<input type="checkbox"/>	<input type="checkbox"/>	<input type="checkbox"/>	<input type="checkbox"/>	<input type="checkbox"/>	<input type="checkbox"/>	<input type="checkbox"/>	<input type="checkbox"/>	<input type="checkbox"/>	<input type="checkbox"/>	<input type="checkbox"/>	<input type="checkbox"/>
<input type="checkbox"/>	<input type="checkbox"/>	<input type="checkbox"/>	<input type="checkbox"/>	<input type="checkbox"/>	<input type="checkbox"/>	<input type="checkbox"/>	<input type="checkbox"/>	<input type="checkbox"/>	<input type="checkbox"/>	<input type="checkbox"/>	<input type="checkbox"/>	<input type="checkbox"/>

<input type="checkbox"/>	<input type="checkbox"/>	<input type="checkbox"/>	<input type="checkbox"/>	<input type="checkbox"/>	<input type="checkbox"/>	<input type="checkbox"/>	<input type="checkbox"/>	<input type="checkbox"/>	<input type="checkbox"/>	<input type="checkbox"/>	<input type="checkbox"/>	<input type="checkbox"/>
<input type="checkbox"/>	<input type="checkbox"/>	<input type="checkbox"/>	<input type="checkbox"/>	<input type="checkbox"/>	<input type="checkbox"/>	<input type="checkbox"/>	<input type="checkbox"/>	<input type="checkbox"/>	<input type="checkbox"/>	<input type="checkbox"/>	<input type="checkbox"/>	<input type="checkbox"/>
<input type="checkbox"/>	<input type="checkbox"/>	<input type="checkbox"/>	<input type="checkbox"/>	<input type="checkbox"/>	<input type="checkbox"/>	<input type="checkbox"/>	<input type="checkbox"/>	<input type="checkbox"/>	<input type="checkbox"/>	<input type="checkbox"/>	<input type="checkbox"/>	<input type="checkbox"/>
<input type="checkbox"/>	<input type="checkbox"/>	<input type="checkbox"/>	<input type="checkbox"/>	<input type="checkbox"/>	<input type="checkbox"/>	<input type="checkbox"/>	<input type="checkbox"/>	<input type="checkbox"/>	<input type="checkbox"/>	<input type="checkbox"/>	<input type="checkbox"/>	<input type="checkbox"/>
<input type="checkbox"/>	<input type="checkbox"/>	<input type="checkbox"/>	<input type="checkbox"/>	<input type="checkbox"/>	<input type="checkbox"/>	<input type="checkbox"/>	<input type="checkbox"/>	<input type="checkbox"/>	<input type="checkbox"/>	<input type="checkbox"/>	<input type="checkbox"/>	<input type="checkbox"/>

<input type="checkbox"/>	<input type="checkbox"/>	<input type="checkbox"/>	<input type="checkbox"/>	<input type="checkbox"/>	<input type="checkbox"/>	<input type="checkbox"/>	<input type="checkbox"/>	<input type="checkbox"/>	<input type="checkbox"/>	<input type="checkbox"/>	<input type="checkbox"/>	<input type="checkbox"/>
--------------------------	--------------------------	--------------------------	--------------------------	--------------------------	--------------------------	--------------------------	--------------------------	--------------------------	--------------------------	--------------------------	--------------------------	--------------------------



## Conseils de montage

1. Lisez attentivement les instructions de montage.
2. Identifiez les composants du meuble.
3. Regroupez et vérifiez la quincaillerie.
4. Utilisez les outils nécessaires.
5. Préparez une zone de montage.
6. Effectuez le montage.



## Conseils d'entretien et de nettoyage

- Ne forcez jamais les connexions.
- Resserrez les vis après une période d'utilisation.
- Conservez le manuel de montage ; en cas de pièce manquante, c'est le moyen le plus simple de contacter le magasin.
- N'utilisez pas de poudres abrasives, laine d'acier ou solvants.
- Ne mouillez pas le produit.
- Enlevez délicatement la poussière.
- Utilisez un chiffon légèrement humide.

Instructions d'entretien	
Chiffon doux légèrement humide	<input type="checkbox"/>
Eau savonneuse	<input type="checkbox"/>
Eau avec détergent	<input type="checkbox"/>
Éponge non abrasive	<input type="checkbox"/>
Entretien spécifique du fabricant	<input type="checkbox"/>

⚠ Avertissements ⚠	
Avant tout entretien, enlever la poussière avec soin	<input type="checkbox"/>
Toute tache doit être nettoyée rapidement	<input type="checkbox"/>
N'utilisez jamais de produit abrasif (poudre, laine d'acier)	<input type="checkbox"/>
N'utilisez jamais de solvant	<input type="checkbox"/>
Ne pas mouiller	<input type="checkbox"/>
Ne pas nettoyer avec un nettoyeur haute pression (produits extérieurs)	<input type="checkbox"/>

Informations spécifiques	
Consultez les informations supplémentaires jointes au produit.	<input type="checkbox"/>

Matériaux												
Bois massif huilé	<input type="checkbox"/>	<input type="checkbox"/>	<input type="checkbox"/>	<input type="checkbox"/>	<input type="checkbox"/>	<input type="checkbox"/>	<input type="checkbox"/>	<input type="checkbox"/>	<input type="checkbox"/>	<input type="checkbox"/>	<input type="checkbox"/>	<input type="checkbox"/>
Bois ciré	<input type="checkbox"/>	<input type="checkbox"/>	<input type="checkbox"/>	<input type="checkbox"/>	<input type="checkbox"/>	<input type="checkbox"/>	<input type="checkbox"/>	<input type="checkbox"/>	<input type="checkbox"/>	<input type="checkbox"/>	<input type="checkbox"/>	<input type="checkbox"/>
Bois verni ou teinté	<input type="checkbox"/>	<input type="checkbox"/>	<input type="checkbox"/>	<input type="checkbox"/>	<input type="checkbox"/>	<input type="checkbox"/>	<input type="checkbox"/>	<input type="checkbox"/>	<input type="checkbox"/>	<input type="checkbox"/>	<input type="checkbox"/>	<input type="checkbox"/>
Panneau bois avec papier décoratif	<input type="checkbox"/>	<input type="checkbox"/>	<input type="checkbox"/>	<input type="checkbox"/>	<input type="checkbox"/>	<input type="checkbox"/>	<input type="checkbox"/>	<input type="checkbox"/>	<input type="checkbox"/>	<input type="checkbox"/>	<input type="checkbox"/>	<input type="checkbox"/>
Panneaux revêtus de mélamine	<input type="checkbox"/>	<input type="checkbox"/>	<input type="checkbox"/>	<input type="checkbox"/>	<input type="checkbox"/>	<input type="checkbox"/>	<input type="checkbox"/>	<input type="checkbox"/>	<input type="checkbox"/>	<input type="checkbox"/>	<input type="checkbox"/>	<input type="checkbox"/>
Surface laquée	<input type="checkbox"/>	<input type="checkbox"/>	<input type="checkbox"/>	<input type="checkbox"/>	<input type="checkbox"/>	<input type="checkbox"/>	<input type="checkbox"/>	<input type="checkbox"/>	<input type="checkbox"/>	<input type="checkbox"/>	<input type="checkbox"/>	<input type="checkbox"/>
Pierres	<input type="checkbox"/>	<input type="checkbox"/>	<input type="checkbox"/>	<input type="checkbox"/>	<input type="checkbox"/>	<input type="checkbox"/>	<input type="checkbox"/>	<input type="checkbox"/>	<input type="checkbox"/>	<input type="checkbox"/>	<input type="checkbox"/>	<input type="checkbox"/>
Cuir	<input type="checkbox"/>	<input type="checkbox"/>	<input type="checkbox"/>	<input type="checkbox"/>	<input type="checkbox"/>	<input type="checkbox"/>	<input type="checkbox"/>	<input type="checkbox"/>	<input type="checkbox"/>	<input type="checkbox"/>	<input type="checkbox"/>	<input type="checkbox"/>
Métal	<input type="checkbox"/>	<input type="checkbox"/>	<input type="checkbox"/>	<input type="checkbox"/>	<input type="checkbox"/>	<input type="checkbox"/>	<input type="checkbox"/>	<input type="checkbox"/>	<input type="checkbox"/>	<input type="checkbox"/>	<input type="checkbox"/>	<input type="checkbox"/>
Plastique	<input type="checkbox"/>	<input type="checkbox"/>	<input type="checkbox"/>	<input type="checkbox"/>	<input type="checkbox"/>	<input type="checkbox"/>	<input type="checkbox"/>	<input type="checkbox"/>	<input type="checkbox"/>	<input type="checkbox"/>	<input type="checkbox"/>	<input type="checkbox"/>
Tissu	<input type="checkbox"/>	<input type="checkbox"/>	<input type="checkbox"/>	<input type="checkbox"/>	<input type="checkbox"/>	<input type="checkbox"/>	<input type="checkbox"/>	<input type="checkbox"/>	<input type="checkbox"/>	<input type="checkbox"/>	<input type="checkbox"/>	<input type="checkbox"/>
Tissu enduit (PU, PVC)	<input type="checkbox"/>	<input type="checkbox"/>	<input type="checkbox"/>	<input type="checkbox"/>	<input type="checkbox"/>	<input type="checkbox"/>	<input type="checkbox"/>	<input type="checkbox"/>	<input type="checkbox"/>	<input type="checkbox"/>	<input type="checkbox"/>	<input type="checkbox"/>
Produit avec éléments électriques	<input type="checkbox"/>	<input type="checkbox"/>	<input type="checkbox"/>	<input type="checkbox"/>	<input type="checkbox"/>	<input type="checkbox"/>	<input type="checkbox"/>	<input type="checkbox"/>	<input type="checkbox"/>	<input type="checkbox"/>	<input type="checkbox"/>	<input type="checkbox"/>

<input type="checkbox"/>	<input type="checkbox"/>	<input type="checkbox"/>	<input type="checkbox"/>	<input type="checkbox"/>	<input type="checkbox"/>	<input type="checkbox"/>	<input type="checkbox"/>	<input type="checkbox"/>	<input type="checkbox"/>	<input type="checkbox"/>	<input type="checkbox"/>	<input type="checkbox"/>
<input type="checkbox"/>	<input type="checkbox"/>	<input type="checkbox"/>	<input type="checkbox"/>	<input type="checkbox"/>	<input type="checkbox"/>	<input type="checkbox"/>	<input type="checkbox"/>	<input type="checkbox"/>	<input type="checkbox"/>	<input type="checkbox"/>	<input type="checkbox"/>	<input type="checkbox"/>
<input type="checkbox"/>	<input type="checkbox"/>	<input type="checkbox"/>	<input type="checkbox"/>	<input type="checkbox"/>	<input type="checkbox"/>	<input type="checkbox"/>	<input type="checkbox"/>	<input type="checkbox"/>	<input type="checkbox"/>	<input type="checkbox"/>	<input type="checkbox"/>	<input type="checkbox"/>
<input type="checkbox"/>	<input type="checkbox"/>	<input type="checkbox"/>	<input type="checkbox"/>	<input type="checkbox"/>	<input type="checkbox"/>	<input type="checkbox"/>	<input type="checkbox"/>	<input type="checkbox"/>	<input type="checkbox"/>	<input type="checkbox"/>	<input type="checkbox"/>	<input type="checkbox"/>
<input type="checkbox"/>	<input type="checkbox"/>	<input type="checkbox"/>	<input type="checkbox"/>	<input type="checkbox"/>	<input type="checkbox"/>	<input type="checkbox"/>	<input type="checkbox"/>	<input type="checkbox"/>	<input type="checkbox"/>	<input type="checkbox"/>	<input type="checkbox"/>	<input type="checkbox"/>

<input type="checkbox"/>	<input type="checkbox"/>	<input type="checkbox"/>	<input type="checkbox"/>	<input type="checkbox"/>	<input type="checkbox"/>	<input type="checkbox"/>	<input type="checkbox"/>	<input type="checkbox"/>	<input type="checkbox"/>	<input type="checkbox"/>	<input type="checkbox"/>	<input type="checkbox"/>
<input type="checkbox"/>	<input type="checkbox"/>	<input type="checkbox"/>	<input type="checkbox"/>	<input type="checkbox"/>	<input type="checkbox"/>	<input type="checkbox"/>	<input type="checkbox"/>	<input type="checkbox"/>	<input type="checkbox"/>	<input type="checkbox"/>	<input type="checkbox"/>	<input type="checkbox"/>
<input type="checkbox"/>	<input type="checkbox"/>	<input type="checkbox"/>	<input type="checkbox"/>	<input type="checkbox"/>	<input type="checkbox"/>	<input type="checkbox"/>	<input type="checkbox"/>	<input type="checkbox"/>	<input type="checkbox"/>	<input type="checkbox"/>	<input type="checkbox"/>	<input type="checkbox"/>
<input type="checkbox"/>	<input type="checkbox"/>	<input type="checkbox"/>	<input type="checkbox"/>	<input type="checkbox"/>	<input type="checkbox"/>	<input type="checkbox"/>	<input type="checkbox"/>	<input type="checkbox"/>	<input type="checkbox"/>	<input type="checkbox"/>	<input type="checkbox"/>	<input type="checkbox"/>
<input type="checkbox"/>	<input type="checkbox"/>	<input type="checkbox"/>	<input type="checkbox"/>	<input type="checkbox"/>	<input type="checkbox"/>	<input type="checkbox"/>	<input type="checkbox"/>	<input type="checkbox"/>	<input type="checkbox"/>	<input type="checkbox"/>	<input type="checkbox"/>	<input type="checkbox"/>

<input type="checkbox"/>	<input type="checkbox"/>	<input type="checkbox"/>	<input type="checkbox"/>	<input type="checkbox"/>	<input type="checkbox"/>	<input type="checkbox"/>	<input type="checkbox"/>	<input type="checkbox"/>	<input type="checkbox"/>	<input type="checkbox"/>	<input type="checkbox"/>	<input type="checkbox"/>
--------------------------	--------------------------	--------------------------	--------------------------	--------------------------	--------------------------	--------------------------	--------------------------	--------------------------	--------------------------	--------------------------	--------------------------	--------------------------



**Consigli di montaggio**

1. Leggere attentamente le istruzioni di montaggio.
2. Identificare i componenti del mobile.
3. Raggruppare e controllare la ferramenta.
4. Utilizzare gli strumenti necessari.
5. Creare una zona per il montaggio.
6. Eseguire il montaggio.



**Consigli per la manutenzione e la pulizia**

- Non forzare mai i collegamenti.
- Stringere le viti dopo un certo periodo d'uso.
- Conservare il manuale di montaggio; se manca un pezzo, è il modo più semplice per contattare il negozio.
- Non utilizzare polveri abrasive, lana d'acciaio o solventi.
- Non bagnare il prodotto.
- Rimuovere delicatamente la polvere.
- Usare un panno leggermente umido.

Istruzioni per la manutenzione	
Panno morbido leggermente umido	<input type="checkbox"/>
Acqua saponata	<input type="checkbox"/>
Acqua con detergente	<input type="checkbox"/>
Spugna antigraffio	<input type="checkbox"/>
Manutenzione specifica del produttore	<input type="checkbox"/>

⚠ Avvertenze ⚠	
Prima di ogni manutenzione, rimuovere la polvere con cura	<input type="checkbox"/>
Qualsiasi macchia deve essere pulita subito	<input type="checkbox"/>
Non usare mai prodotti abrasivi (polvere, lana d'acciaio)	<input type="checkbox"/>
Non usare solventi	<input type="checkbox"/>
Non bagnare	<input type="checkbox"/>
Non pulire con idropulitrice (prodotti da esterno)	<input type="checkbox"/>

Informazioni specifiche	
Consultare le informazioni aggiuntive allegate al prodotto.	<input type="checkbox"/>

Materiali												
Legno massiccio oliato	<input type="checkbox"/>	<input type="checkbox"/>	<input type="checkbox"/>	<input type="checkbox"/>	<input type="checkbox"/>	<input type="checkbox"/>	<input type="checkbox"/>	<input type="checkbox"/>	<input type="checkbox"/>	<input type="checkbox"/>	<input type="checkbox"/>	<input type="checkbox"/>
Legno cerato	<input type="checkbox"/>	<input type="checkbox"/>	<input type="checkbox"/>	<input type="checkbox"/>	<input type="checkbox"/>	<input type="checkbox"/>	<input type="checkbox"/>	<input type="checkbox"/>	<input type="checkbox"/>	<input type="checkbox"/>	<input type="checkbox"/>	<input type="checkbox"/>
Legno verniciato o tinto	<input type="checkbox"/>	<input type="checkbox"/>	<input type="checkbox"/>	<input type="checkbox"/>	<input type="checkbox"/>	<input type="checkbox"/>	<input type="checkbox"/>	<input type="checkbox"/>	<input type="checkbox"/>	<input type="checkbox"/>	<input type="checkbox"/>	<input type="checkbox"/>
Pannello in legno con carta decorativa	<input type="checkbox"/>	<input type="checkbox"/>	<input type="checkbox"/>	<input type="checkbox"/>	<input type="checkbox"/>	<input type="checkbox"/>	<input type="checkbox"/>	<input type="checkbox"/>	<input type="checkbox"/>	<input type="checkbox"/>	<input type="checkbox"/>	<input type="checkbox"/>
Pannelli rivestiti in melamina	<input type="checkbox"/>	<input type="checkbox"/>	<input type="checkbox"/>	<input type="checkbox"/>	<input type="checkbox"/>	<input type="checkbox"/>	<input type="checkbox"/>	<input type="checkbox"/>	<input type="checkbox"/>	<input type="checkbox"/>	<input type="checkbox"/>	<input type="checkbox"/>
Superficie laccata	<input type="checkbox"/>	<input type="checkbox"/>	<input type="checkbox"/>	<input type="checkbox"/>	<input type="checkbox"/>	<input type="checkbox"/>	<input type="checkbox"/>	<input type="checkbox"/>	<input type="checkbox"/>	<input type="checkbox"/>	<input type="checkbox"/>	<input type="checkbox"/>
Pietre	<input type="checkbox"/>	<input type="checkbox"/>	<input type="checkbox"/>	<input type="checkbox"/>	<input type="checkbox"/>	<input type="checkbox"/>	<input type="checkbox"/>	<input type="checkbox"/>	<input type="checkbox"/>	<input type="checkbox"/>	<input type="checkbox"/>	<input type="checkbox"/>
Pelle	<input type="checkbox"/>	<input type="checkbox"/>	<input type="checkbox"/>	<input type="checkbox"/>	<input type="checkbox"/>	<input type="checkbox"/>	<input type="checkbox"/>	<input type="checkbox"/>	<input type="checkbox"/>	<input type="checkbox"/>	<input type="checkbox"/>	<input type="checkbox"/>
Metallo	<input type="checkbox"/>	<input type="checkbox"/>	<input type="checkbox"/>	<input type="checkbox"/>	<input type="checkbox"/>	<input type="checkbox"/>	<input type="checkbox"/>	<input type="checkbox"/>	<input type="checkbox"/>	<input type="checkbox"/>	<input type="checkbox"/>	<input type="checkbox"/>
Plastica	<input type="checkbox"/>	<input type="checkbox"/>	<input type="checkbox"/>	<input type="checkbox"/>	<input type="checkbox"/>	<input type="checkbox"/>	<input type="checkbox"/>	<input type="checkbox"/>	<input type="checkbox"/>	<input type="checkbox"/>	<input type="checkbox"/>	<input type="checkbox"/>
Tessuto	<input type="checkbox"/>	<input type="checkbox"/>	<input type="checkbox"/>	<input type="checkbox"/>	<input type="checkbox"/>	<input type="checkbox"/>	<input type="checkbox"/>	<input type="checkbox"/>	<input type="checkbox"/>	<input type="checkbox"/>	<input type="checkbox"/>	<input type="checkbox"/>
Tessuto spalmato (PU, PVC)	<input type="checkbox"/>	<input type="checkbox"/>	<input type="checkbox"/>	<input type="checkbox"/>	<input type="checkbox"/>	<input type="checkbox"/>	<input type="checkbox"/>	<input type="checkbox"/>	<input type="checkbox"/>	<input type="checkbox"/>	<input type="checkbox"/>	<input type="checkbox"/>
Prodotto con parti elettriche	<input type="checkbox"/>	<input type="checkbox"/>	<input type="checkbox"/>	<input type="checkbox"/>	<input type="checkbox"/>	<input type="checkbox"/>	<input type="checkbox"/>	<input type="checkbox"/>	<input type="checkbox"/>	<input type="checkbox"/>	<input type="checkbox"/>	<input type="checkbox"/>

<input type="checkbox"/>	<input type="checkbox"/>	<input type="checkbox"/>	<input type="checkbox"/>	<input type="checkbox"/>	<input type="checkbox"/>	<input type="checkbox"/>	<input type="checkbox"/>	<input type="checkbox"/>	<input type="checkbox"/>	<input type="checkbox"/>	<input type="checkbox"/>	<input type="checkbox"/>
<input type="checkbox"/>	<input type="checkbox"/>	<input type="checkbox"/>	<input type="checkbox"/>	<input type="checkbox"/>	<input type="checkbox"/>	<input type="checkbox"/>	<input type="checkbox"/>	<input type="checkbox"/>	<input type="checkbox"/>	<input type="checkbox"/>	<input type="checkbox"/>	<input type="checkbox"/>
<input type="checkbox"/>	<input type="checkbox"/>	<input type="checkbox"/>	<input type="checkbox"/>	<input type="checkbox"/>	<input type="checkbox"/>	<input type="checkbox"/>	<input type="checkbox"/>	<input type="checkbox"/>	<input type="checkbox"/>	<input type="checkbox"/>	<input type="checkbox"/>	<input type="checkbox"/>
<input type="checkbox"/>	<input type="checkbox"/>	<input type="checkbox"/>	<input type="checkbox"/>	<input type="checkbox"/>	<input type="checkbox"/>	<input type="checkbox"/>	<input type="checkbox"/>	<input type="checkbox"/>	<input type="checkbox"/>	<input type="checkbox"/>	<input type="checkbox"/>	<input type="checkbox"/>
<input type="checkbox"/>	<input type="checkbox"/>	<input type="checkbox"/>	<input type="checkbox"/>	<input type="checkbox"/>	<input type="checkbox"/>	<input type="checkbox"/>	<input type="checkbox"/>	<input type="checkbox"/>	<input type="checkbox"/>	<input type="checkbox"/>	<input type="checkbox"/>	<input type="checkbox"/>

<input type="checkbox"/>	<input type="checkbox"/>	<input type="checkbox"/>	<input type="checkbox"/>	<input type="checkbox"/>	<input type="checkbox"/>	<input type="checkbox"/>	<input type="checkbox"/>	<input type="checkbox"/>	<input type="checkbox"/>	<input type="checkbox"/>	<input type="checkbox"/>	<input type="checkbox"/>
<input type="checkbox"/>	<input type="checkbox"/>	<input type="checkbox"/>	<input type="checkbox"/>	<input type="checkbox"/>	<input type="checkbox"/>	<input type="checkbox"/>	<input type="checkbox"/>	<input type="checkbox"/>	<input type="checkbox"/>	<input type="checkbox"/>	<input type="checkbox"/>	<input type="checkbox"/>
<input type="checkbox"/>	<input type="checkbox"/>	<input type="checkbox"/>	<input type="checkbox"/>	<input type="checkbox"/>	<input type="checkbox"/>	<input type="checkbox"/>	<input type="checkbox"/>	<input type="checkbox"/>	<input type="checkbox"/>	<input type="checkbox"/>	<input type="checkbox"/>	<input type="checkbox"/>
<input type="checkbox"/>	<input type="checkbox"/>	<input type="checkbox"/>	<input type="checkbox"/>	<input type="checkbox"/>	<input type="checkbox"/>	<input type="checkbox"/>	<input type="checkbox"/>	<input type="checkbox"/>	<input type="checkbox"/>	<input type="checkbox"/>	<input type="checkbox"/>	<input type="checkbox"/>
<input type="checkbox"/>	<input type="checkbox"/>	<input type="checkbox"/>	<input type="checkbox"/>	<input type="checkbox"/>	<input type="checkbox"/>	<input type="checkbox"/>	<input type="checkbox"/>	<input type="checkbox"/>	<input type="checkbox"/>	<input type="checkbox"/>	<input type="checkbox"/>	<input type="checkbox"/>

<input type="checkbox"/>	<input type="checkbox"/>	<input type="checkbox"/>	<input type="checkbox"/>	<input type="checkbox"/>	<input type="checkbox"/>	<input type="checkbox"/>	<input type="checkbox"/>	<input type="checkbox"/>	<input type="checkbox"/>	<input type="checkbox"/>	<input type="checkbox"/>	<input type="checkbox"/>
--------------------------	--------------------------	--------------------------	--------------------------	--------------------------	--------------------------	--------------------------	--------------------------	--------------------------	--------------------------	--------------------------	--------------------------	--------------------------



## Conselhos de montagem

1. Leia atentamente as instruções de montagem.
2. Identifique os componentes do móvel.
3. Agrupe e verifique a ferragem.
4. Use as ferramentas necessárias.
5. Crie uma área para montagem.
6. Faça a montagem.



## Conselhos de manutenção e limpeza

- Nunca force as ligações.
- Aperte os parafusos após algum tempo de uso.
- Guarde o manual de montagem; se faltar alguma peça, é a forma mais fácil de contactar a loja.
- Não use pós abrasivos, palha de aço ou solventes.
- Não molhe o produto.
- Remova cuidadosamente o pó.
- Use um pano ligeiramente húmido.

### Instruções de manutenção

Pano macio ligeiramente húmido
Água com sabão
Água com detergente
Espanja anti-riscos
Manutenção específica do fabricante

Materiais												
Madeira maciça com óleo	Madeira encerada	Madeira envernizada ou tingida	Painel de madeira com papel decorativo	Painéis revestidos com melamina	Superfície lacada	Pedras	Couro	Metal	Plástico	Têxtil	Tecido revestido (PU, PVC)	Produto com partes elétricas

<input type="checkbox"/>	<input type="checkbox"/>	<input type="checkbox"/>	<input type="checkbox"/>	<input type="checkbox"/>	<input type="checkbox"/>	<input type="checkbox"/>	<input type="checkbox"/>	<input type="checkbox"/>	<input type="checkbox"/>	<input type="checkbox"/>	<input type="checkbox"/>	<input type="checkbox"/>
<input type="checkbox"/>	<input type="checkbox"/>	<input type="checkbox"/>	<input type="checkbox"/>	<input type="checkbox"/>	<input type="checkbox"/>	<input type="checkbox"/>	<input type="checkbox"/>	<input type="checkbox"/>	<input type="checkbox"/>	<input type="checkbox"/>	<input type="checkbox"/>	<input type="checkbox"/>
<input type="checkbox"/>	<input type="checkbox"/>	<input type="checkbox"/>	<input type="checkbox"/>	<input type="checkbox"/>	<input type="checkbox"/>	<input type="checkbox"/>	<input type="checkbox"/>	<input type="checkbox"/>	<input type="checkbox"/>	<input type="checkbox"/>	<input type="checkbox"/>	<input type="checkbox"/>
<input type="checkbox"/>	<input type="checkbox"/>	<input type="checkbox"/>	<input type="checkbox"/>	<input type="checkbox"/>	<input type="checkbox"/>	<input type="checkbox"/>	<input type="checkbox"/>	<input type="checkbox"/>	<input type="checkbox"/>	<input type="checkbox"/>	<input type="checkbox"/>	<input type="checkbox"/>

### Advertências

Antes de qualquer manutenção, limpe cuidadosamente o pó
Qualquer mancha deve ser limpa rapidamente
Nunca use produtos abrasivos (pó, palha de aço)
Nunca use solventes
Não molhar
Não limpar com lavadora de alta pressão (produtos de exterior)

<input type="checkbox"/>	<input type="checkbox"/>	<input type="checkbox"/>	<input type="checkbox"/>	<input type="checkbox"/>	<input type="checkbox"/>	<input type="checkbox"/>	<input type="checkbox"/>	<input type="checkbox"/>	<input type="checkbox"/>	<input type="checkbox"/>	<input type="checkbox"/>	<input type="checkbox"/>
<input type="checkbox"/>	<input type="checkbox"/>	<input type="checkbox"/>	<input type="checkbox"/>	<input type="checkbox"/>	<input type="checkbox"/>	<input type="checkbox"/>	<input type="checkbox"/>	<input type="checkbox"/>	<input type="checkbox"/>	<input type="checkbox"/>	<input type="checkbox"/>	<input type="checkbox"/>
<input type="checkbox"/>	<input type="checkbox"/>	<input type="checkbox"/>	<input type="checkbox"/>	<input type="checkbox"/>	<input type="checkbox"/>	<input type="checkbox"/>	<input type="checkbox"/>	<input type="checkbox"/>	<input type="checkbox"/>	<input type="checkbox"/>	<input type="checkbox"/>	<input type="checkbox"/>
<input type="checkbox"/>	<input type="checkbox"/>	<input type="checkbox"/>	<input type="checkbox"/>	<input type="checkbox"/>	<input type="checkbox"/>	<input type="checkbox"/>	<input type="checkbox"/>	<input type="checkbox"/>	<input type="checkbox"/>	<input type="checkbox"/>	<input type="checkbox"/>	<input type="checkbox"/>
<input type="checkbox"/>	<input type="checkbox"/>	<input type="checkbox"/>	<input type="checkbox"/>	<input type="checkbox"/>	<input type="checkbox"/>	<input type="checkbox"/>	<input type="checkbox"/>	<input type="checkbox"/>	<input type="checkbox"/>	<input type="checkbox"/>	<input type="checkbox"/>	<input type="checkbox"/>

### Informações específicas

Consulte as informações adicionais anexadas ao produto.
---

<input type="checkbox"/>	<input type="checkbox"/>	<input type="checkbox"/>	<input type="checkbox"/>	<input type="checkbox"/>	<input type="checkbox"/>	<input type="checkbox"/>	<input type="checkbox"/>	<input type="checkbox"/>	<input type="checkbox"/>	<input type="checkbox"/>	<input type="checkbox"/>	<input type="checkbox"/>
--------------------------	--------------------------	--------------------------	--------------------------	--------------------------	--------------------------	--------------------------	--------------------------	--------------------------	--------------------------	--------------------------	--------------------------	--------------------------



## Montagehinweise

1. Lesen Sie die Montageanleitung sorgfältig durch.
2. Identifizieren Sie die Möbelteile.
3. Gruppieren und prüfen Sie die Beschläge.
4. Verwenden Sie das notwendige Werkzeug.
5. Richten Sie einen Montagebereich ein.
6. Führen Sie die Montage durch.



## Hinweise zur Pflege und Reinigung

- Erzwingen Sie keine Verbindungen.
- Ziehen Sie die Schrauben nach einer gewissen Nutzungsdauer nach.
- Bewahren Sie die Montageanleitung auf; fehlt ein Teil, ist dies der einfachste Weg, das Geschäft zu kontaktieren.
- Verwenden Sie keine Scheuermittel, Stahlwolle oder Lösungsmittel.
- Nicht nass machen.
- Staub vorsichtig entfernen.
- Ein leicht feuchtes Tuch verwenden.

Pflegehinweise	
Weiches, leicht feuchtes Tuch	
Seifenwasser	
Wasser mit Reinigungsmittel	
Kratzfreie Scheuerschwamm	
Herstellerspezifische Pflege	

Materialien														
Massivholz geölt	Gewachstes Holz	Lackiertes oder gebeiztes Holz	Holzplatte mit Dekorpapier	Melaminbeschichtete Platten	Lackierte Oberfläche	Steine	Leder	Metal	Kunststoff	Textil	Beschichteter Stoff (PU, PVC)	Produkt mit elektrischen Teilen		

<input type="checkbox"/>	<input type="checkbox"/>	<input type="checkbox"/>	<input type="checkbox"/>	<input type="checkbox"/>	<input type="checkbox"/>	<input type="checkbox"/>	<input type="checkbox"/>	<input type="checkbox"/>	<input type="checkbox"/>	<input type="checkbox"/>	<input type="checkbox"/>	<input type="checkbox"/>	<input type="checkbox"/>	<input type="checkbox"/>
<input type="checkbox"/>	<input type="checkbox"/>	<input type="checkbox"/>	<input type="checkbox"/>	<input type="checkbox"/>	<input type="checkbox"/>	<input type="checkbox"/>	<input type="checkbox"/>	<input type="checkbox"/>	<input type="checkbox"/>	<input type="checkbox"/>	<input type="checkbox"/>	<input type="checkbox"/>	<input type="checkbox"/>	<input type="checkbox"/>
<input type="checkbox"/>	<input type="checkbox"/>	<input type="checkbox"/>	<input type="checkbox"/>	<input type="checkbox"/>	<input type="checkbox"/>	<input type="checkbox"/>	<input type="checkbox"/>	<input type="checkbox"/>	<input type="checkbox"/>	<input type="checkbox"/>	<input type="checkbox"/>	<input type="checkbox"/>	<input type="checkbox"/>	<input type="checkbox"/>
<input type="checkbox"/>	<input type="checkbox"/>	<input type="checkbox"/>	<input type="checkbox"/>	<input type="checkbox"/>	<input type="checkbox"/>	<input type="checkbox"/>	<input type="checkbox"/>	<input type="checkbox"/>	<input type="checkbox"/>	<input type="checkbox"/>	<input type="checkbox"/>	<input type="checkbox"/>	<input type="checkbox"/>	<input type="checkbox"/>

⚠ Warnhinweise ⚠	
Vor jeder Wartung Staub sorgfältig entfernen	
Flecken sollten sofort entfernt werden	
Keine scheuernden Produkte verwenden (Pulver, Stahlwolle)	
Keine Lösungsmittel verwenden	
Nicht nass machen	
Nicht mit Hochdruckreiniger reinigen (für Außenprodukte)	

<input type="checkbox"/>	<input type="checkbox"/>	<input type="checkbox"/>	<input type="checkbox"/>	<input type="checkbox"/>	<input type="checkbox"/>	<input type="checkbox"/>	<input type="checkbox"/>	<input type="checkbox"/>	<input type="checkbox"/>	<input type="checkbox"/>	<input type="checkbox"/>	<input type="checkbox"/>	<input type="checkbox"/>	<input type="checkbox"/>
<input type="checkbox"/>	<input type="checkbox"/>	<input type="checkbox"/>	<input type="checkbox"/>	<input type="checkbox"/>	<input type="checkbox"/>	<input type="checkbox"/>	<input type="checkbox"/>	<input type="checkbox"/>	<input type="checkbox"/>	<input type="checkbox"/>	<input type="checkbox"/>	<input type="checkbox"/>	<input type="checkbox"/>	<input type="checkbox"/>
<input type="checkbox"/>	<input type="checkbox"/>	<input type="checkbox"/>	<input type="checkbox"/>	<input type="checkbox"/>	<input type="checkbox"/>	<input type="checkbox"/>	<input type="checkbox"/>	<input type="checkbox"/>	<input type="checkbox"/>	<input type="checkbox"/>	<input type="checkbox"/>	<input type="checkbox"/>	<input type="checkbox"/>	<input type="checkbox"/>
<input type="checkbox"/>	<input type="checkbox"/>	<input type="checkbox"/>	<input type="checkbox"/>	<input type="checkbox"/>	<input type="checkbox"/>	<input type="checkbox"/>	<input type="checkbox"/>	<input type="checkbox"/>	<input type="checkbox"/>	<input type="checkbox"/>	<input type="checkbox"/>	<input type="checkbox"/>	<input type="checkbox"/>	<input type="checkbox"/>

Spezifische Informationen	
Beachten Sie die dem Produkt beiliegenden zusätzlichen Informationen.	

<input type="checkbox"/>	<input type="checkbox"/>	<input type="checkbox"/>	<input type="checkbox"/>	<input type="checkbox"/>	<input type="checkbox"/>	<input type="checkbox"/>	<input type="checkbox"/>	<input type="checkbox"/>	<input type="checkbox"/>	<input type="checkbox"/>	<input type="checkbox"/>	<input type="checkbox"/>	<input type="checkbox"/>	<input type="checkbox"/>
--------------------------	--------------------------	--------------------------	--------------------------	--------------------------	--------------------------	--------------------------	--------------------------	--------------------------	--------------------------	--------------------------	--------------------------	--------------------------	--------------------------	--------------------------



**ES: IMPORTANTE: RECICLAJE.**

Una vez finalizado el montaje:

- Deposita la caja de cartón en el contenedor de papel y cartón.
- Deposita las piezas plásticas no reutilizables en el contenedor de plásticos y envases.
- Si no quiere conservar este folleto, deposítalo en el contenedor de papel y cartón.

**FR: IMPORTANT : RECYCLAGE.**

Une fois le montage terminé :

- Déposez la boîte en carton dans le conteneur pour papier et carton.
- Déposez les pièces en plastique non réutilisables dans le conteneur pour plastiques et emballages.
- Si vous ne souhaitez pas conserver ce livret, déposez-le dans le conteneur pour papier et carton.

**PT: IMPORTANTE: RECICLAGEM.**

Após concluir a montagem:

- Coloque a caixa de cartão no contentor de papel e cartão.
- Coloque as peças plásticas não reutilizáveis no contentor de plásticos e embalagens.
- Se não quiser guardar este folheto, coloque-o no contentor de papel e cartão.

**EN: IMPORTANT: RECYCLING.**

Once assembly is complete:

- Place the cardboard box in the paper and cardboard recycling container.
- Place non-reusable plastic parts in the plastic and packaging recycling container.
- If you don't want to keep this leaflet, place it in the paper and cardboard recycling container.

**IT: IMPORTANTE: RICICLAGGIO.**

Una volta completato il montaggio:

- Smaltisci la scatola di cartone nel contenitore per carta e cartone.
- Smaltisci le parti in plastica non riutilizzabili nel contenitore per plastica e imballaggi.
- Se non desideri conservare questo libretto, gettalo nel contenitore per carta e cartone.

**DE: WICHTIG: RECYCLING.**

Nach dem Zusammenbau:

- Entsorge den Karton im Papier- und Kartoncontainer.
- Nicht wiederverwendbare Kunststoffteile gehören in den Container für Kunststoffe und Verpackungen.
- Wenn du dieses Heft nicht aufbewahren möchtest, wirf es in den Papier- und Kartoncontainer.

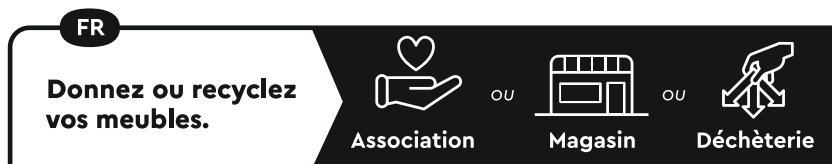
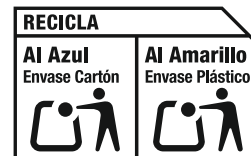

<https://quefairedemesdechets.fr>