

Sehr geehrte Kundin,
sehr geehrter Kunde,

wir freuen uns, dass Sie sich für ein Badmöbel aus unserem Hause entschieden haben.
Unsere Möbel zeichnen sich durch höchste Qualitätsansprüche mit zuverlässiger Funktionalität "Made in Germany" aus.

Sollte es trotz unserer intensiven Qualitätskontrollen zu Fehlteilen oder Beschädigungen gekommen sein, nutzen Sie bitte für die schnelle Nachbestellung von Kleinteilen unseren 24/7 Online-Service unter www.pelipal.de/service/ersatzteilbestellung/



Für eine zuverlässige Bearbeitung benötigen wir von Ihnen dazu:

1. **Die Artikelnummer des Schrankes** (xxx.xxxxxx), die Sie auf der Bauanleitung oder dem jeweiligen Etikett finden
2. **Die Angabe unseres Vertriebspartners**, über den Sie die Möbel erworben haben
3. **Die benötigte Stückzahl** des entsprechenden Bauteils. Bitte nutzen Sie dafür die 2. Seite der Montageanleitung mit der Stückliste.

Bitte beachten Sie, dass Sie größere Bauteile ab einer Länge von 80cm, bzw. ab einer Breite von 30cm aus logistischen Gründen direkt über unseren Vertriebspartner anfordern, bei dem Sie die Möbel erworben haben!

Ihre Zufriedenheit ist uns sehr wichtig!

Daher garantieren wir Ihnen über diesen Weg die schnelle Abwicklung Ihres Anliegens und wünschen Ihnen weiterhin viele Freude mit Ihren neuen Badmöbeln.

Ihr Pelipal-Team



Für den Zusammenbau sind 2 Personen erforderlich.



Montage-Richtzeit 3 Stunden

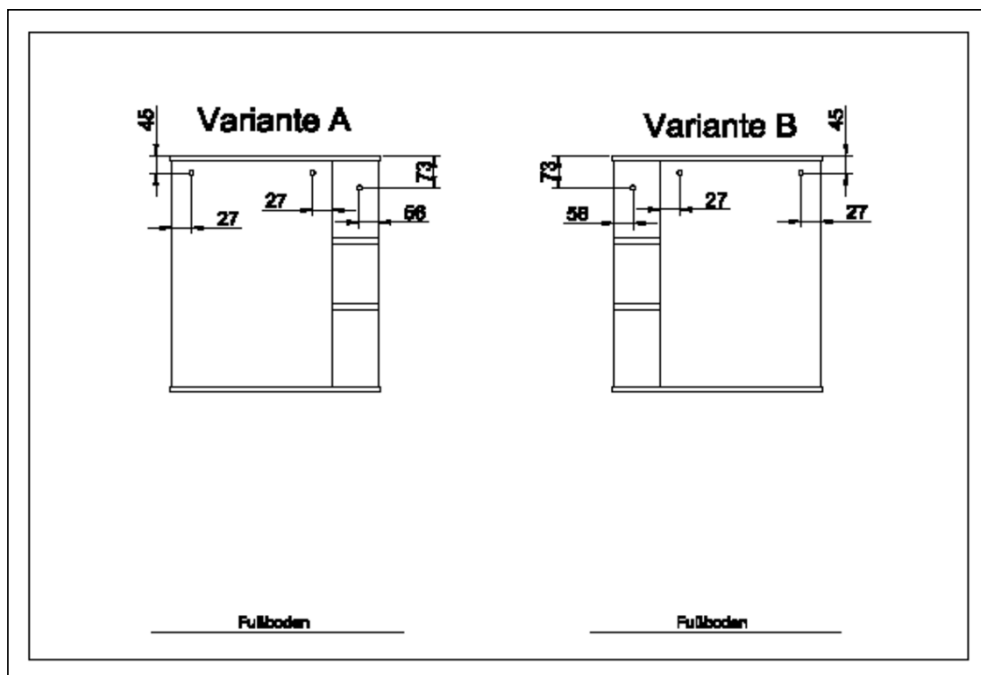

Artikel-Nr.: 963.015030

	Bauteil	Ist Menge	Benötigte Menge
A + B	S-963-015030--	2	
C	P-923-015030-A	1	
D	P-923-015030-B	1	
E	C-923-015030--	1	
F	R-963-015030--	1	
G	RWD-WE1-Z00067G	1	
H	T-963-015030--	1	
J	A-923-015030--	2	
K	GBO-005-0317X0150	2	

a	DUEB-SMD-000005	12	
b	EXZENTER-000015	12	
c	TBD-35-115X00	2	
d	ZPL-003X004	2	
e	ADK-AL1-005X008	2	
f	TUER-DAEM-000010	1	
g	TUER-ADA-000010	1	
h	SCH-SPA-035X015	10	
i	TRAE-001-000020	8	
k	RWD-KEI-000060	4	
l	ADK-WE1-010X013	4	
m	AUF-001-000080	1	
n	AUF-001-000090	1	
o	GRI-128-931010	1	
p	SCH-KNO-M04X022	2	
r	AUF-001-000020	2	
s	AUF-001-000025	1	
t	AUF-001-000055	1	
u	SCH-SPA-035X045	8	
v	DUEB-HLZ-008X030	4	
w	TRAE-005-000010	2	
x	VBD-000020	1	
y	SCH-RDK-045X045	1	
z	SCH-RDK-040X015	1	

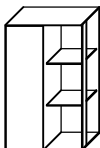



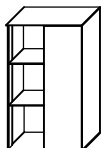





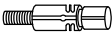

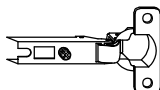

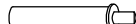
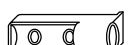



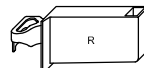
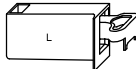

Variante A

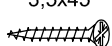

Variante B

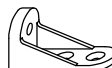
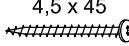
9__-015030

12 x a  DUEB-SMD-000005	12 x b  EXZENTER-000015	2 x c  TBD-35-115X00	2 x d  ZPL-003X004	2 x e  ADK-AL1-005X008	1 x f  TUER-DAEM-000010
1 x g  TUER-ADA-000010	10 x h 3,5 x 15  SCH-SPA-035X015	8 x i  TRAE-001-000020	4 x k  RWD-KEI-000060	4 x l 10 x 13  ADK-WE1-010X013	1 x m  AUF-001-000080
1 x n  AUF-001-000090	1 x o  GRIFF	2 x p  SCH-KNO-M04	2 x r  AUF-001-000020	1 x s  AUF-001-000025	1 x t  AUF-001-000055
8 x u 3,5x45  SCH-SPA-035X045	4 x v  DUEB-HLZ-008X030	2 x w  TRAE-005-000010	1 x x  VBD-000020	1 x y 4,5 x 45  SCH-RDK-045X045	1 x z 4,0 x 15  SCH-RDK-040X015

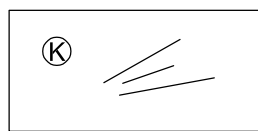
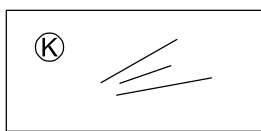
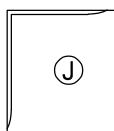
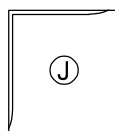
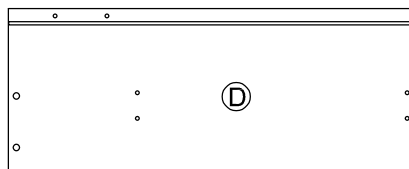
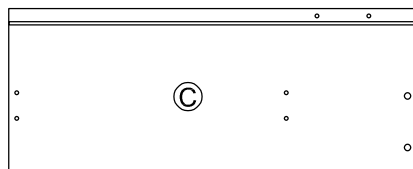
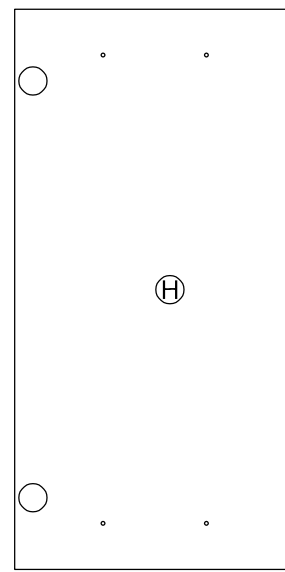
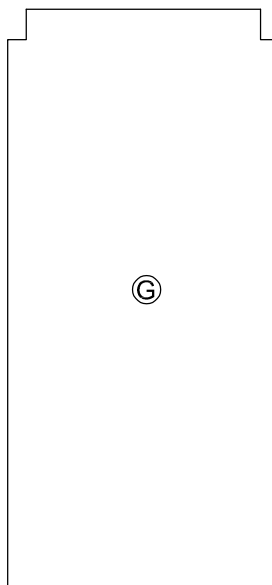
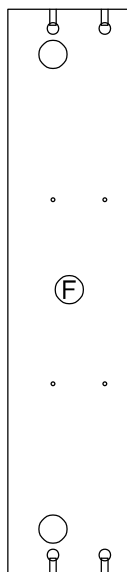
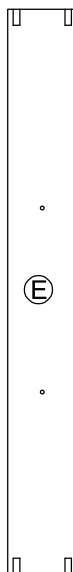
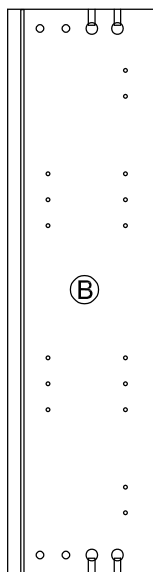
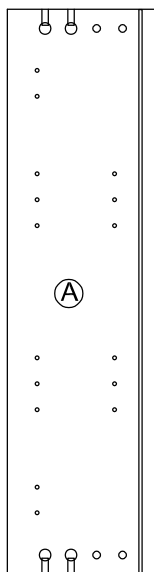

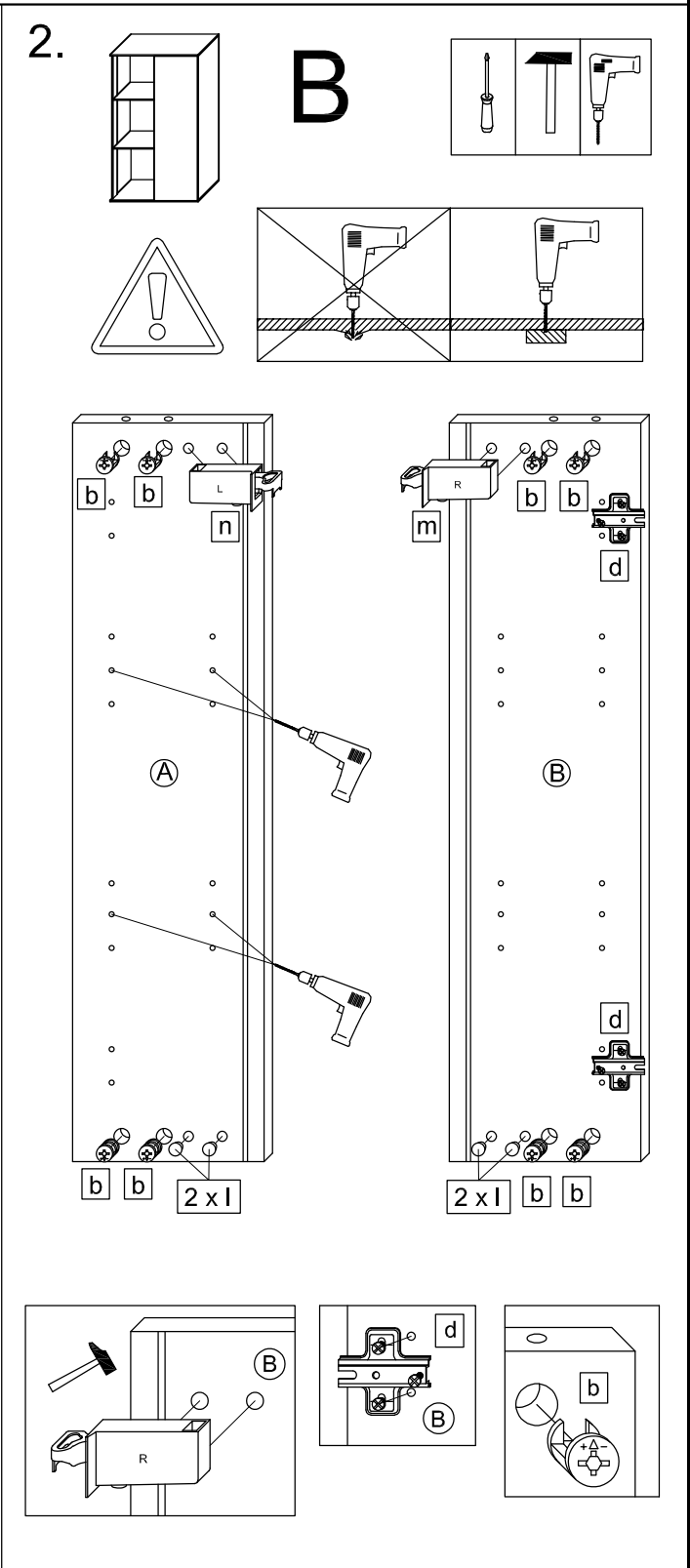
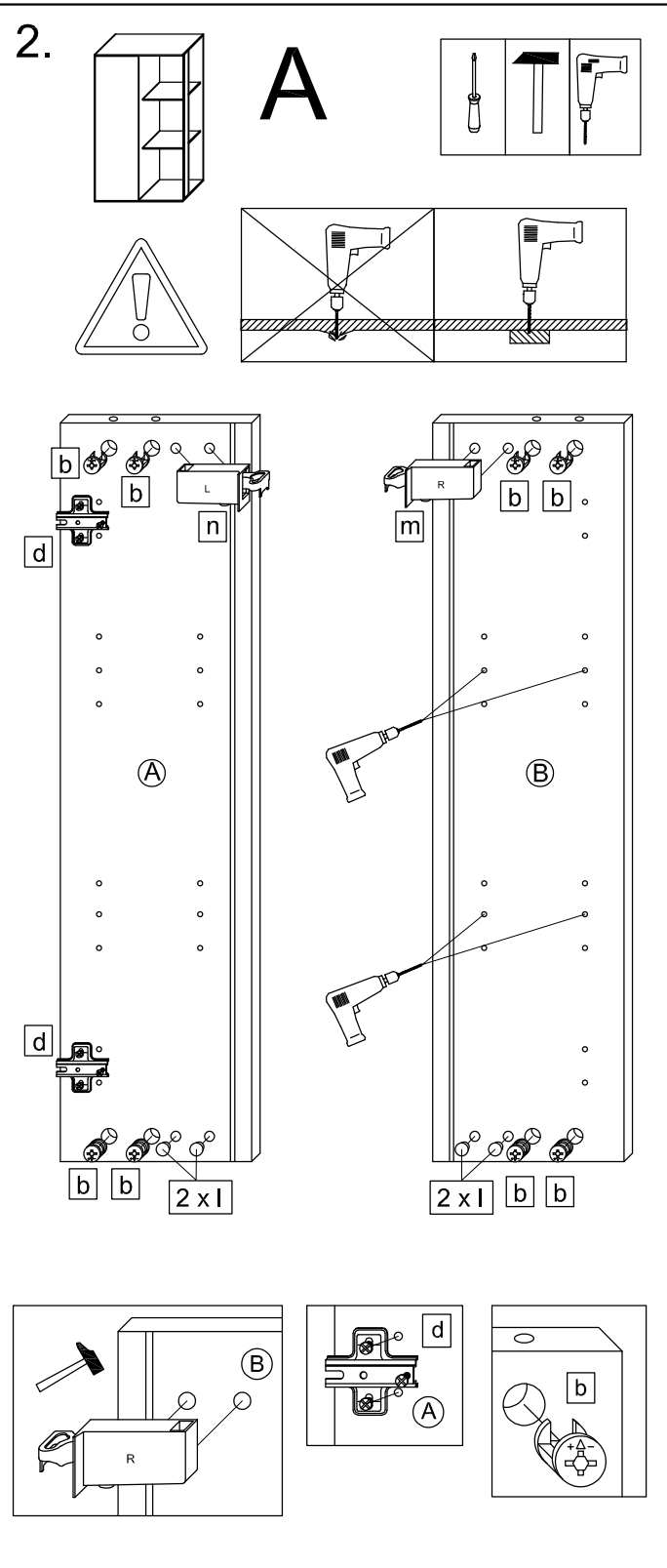
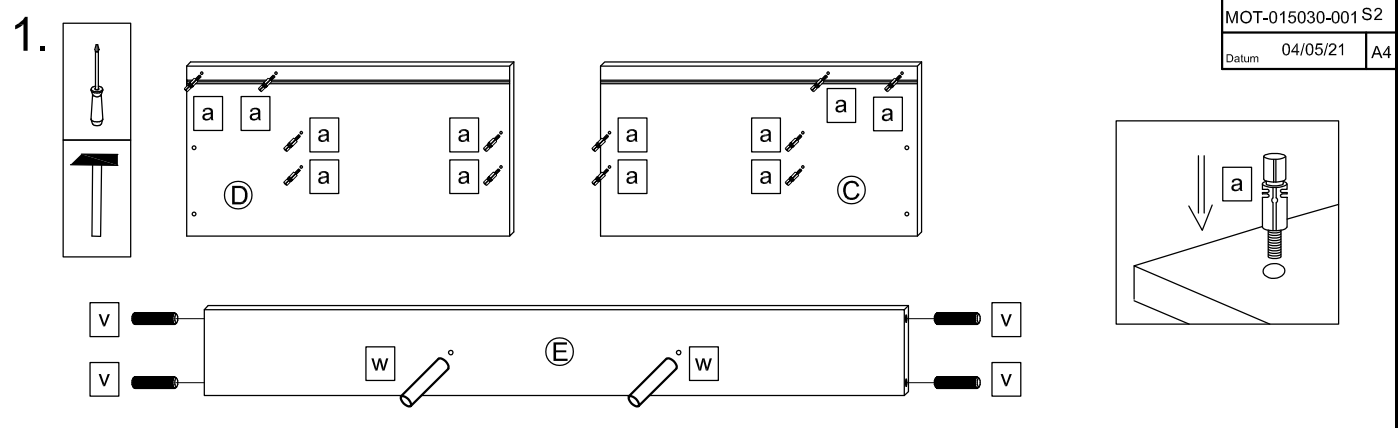

3.

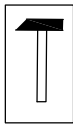

A

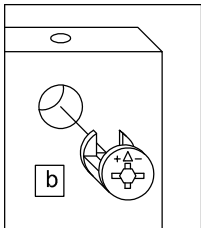
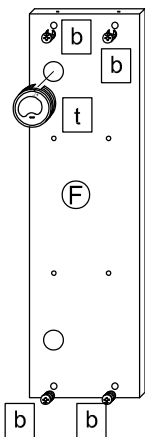

B

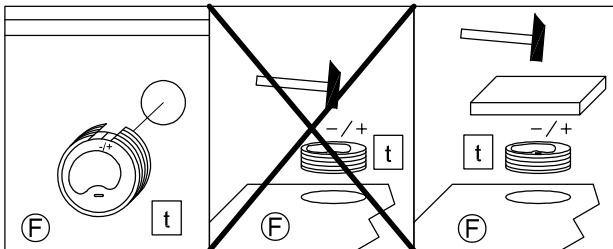
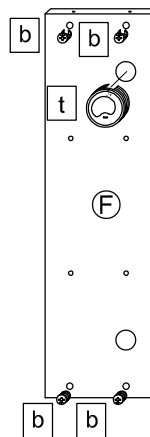

4.

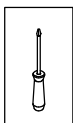

A

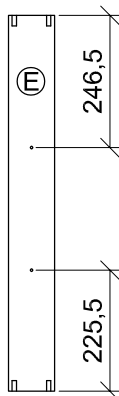
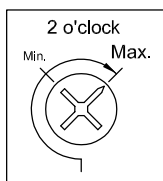
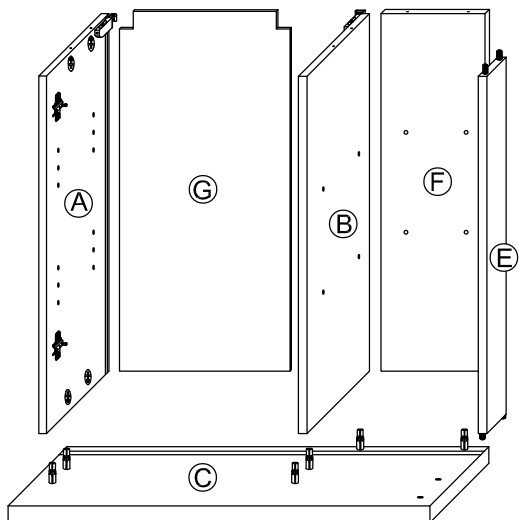

B

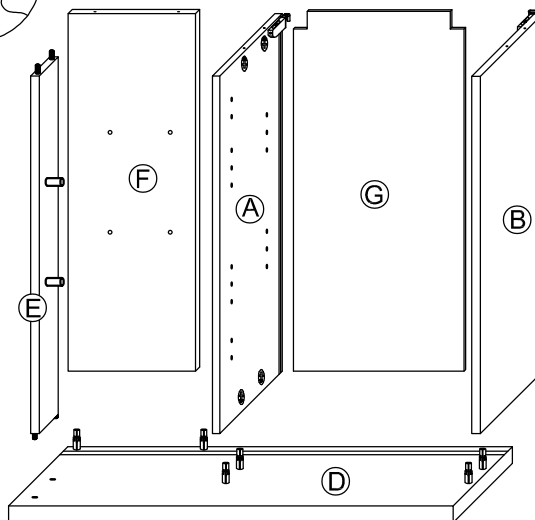

5.

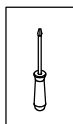

A

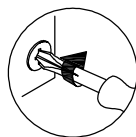
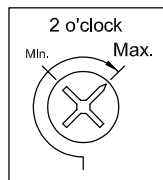
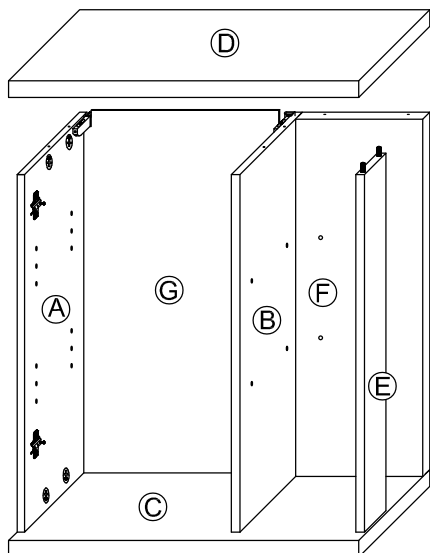

B

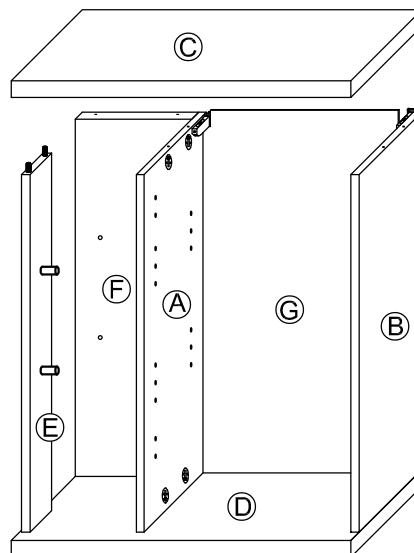

6.

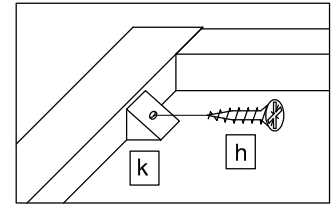
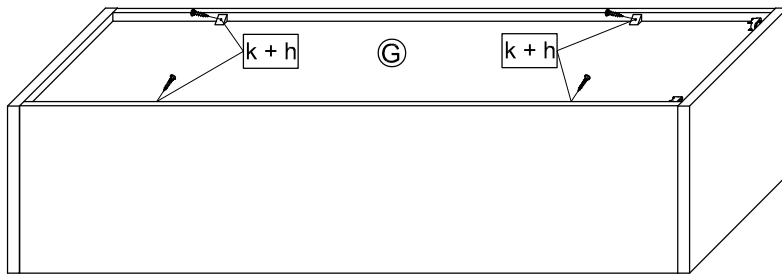
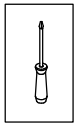

7.

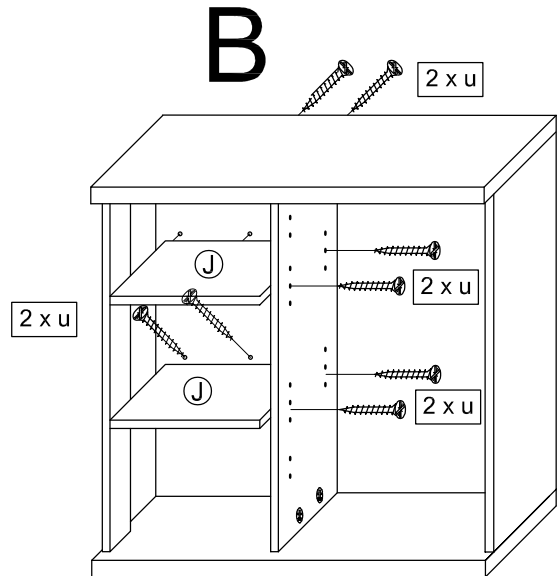
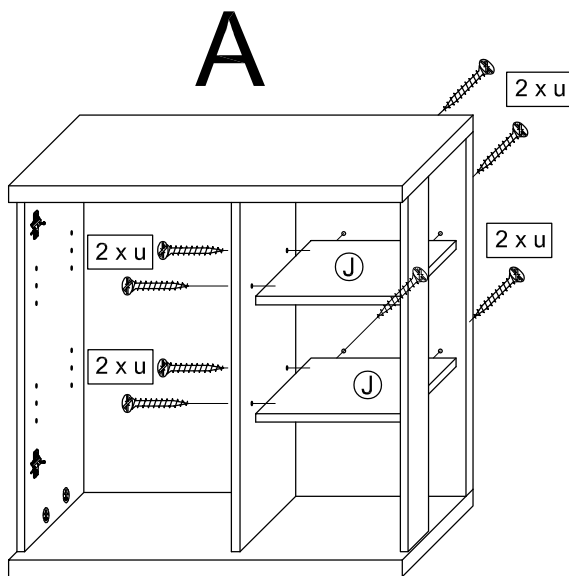
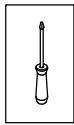

8.

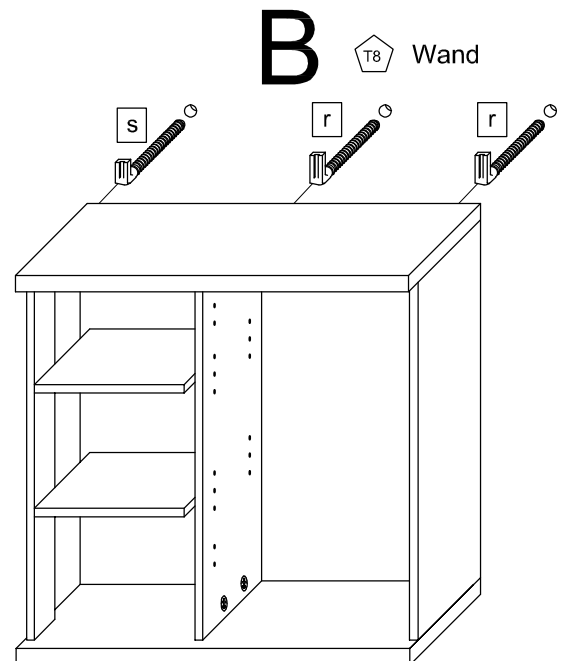
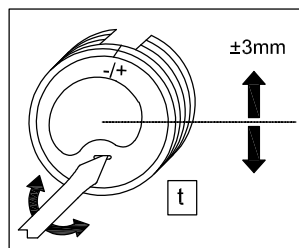
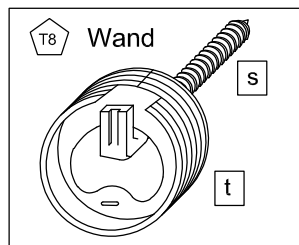
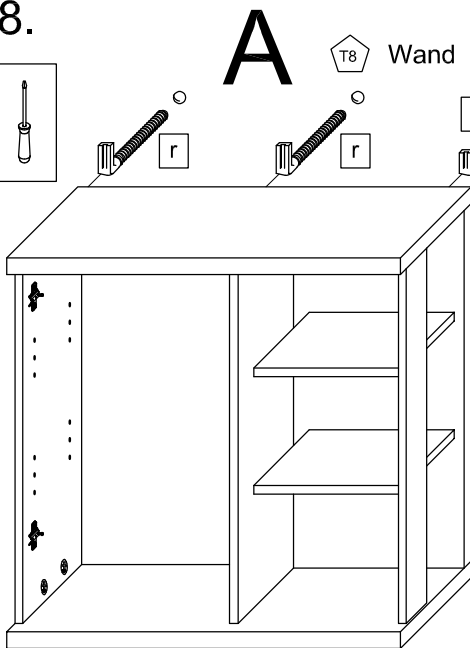
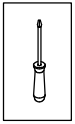

T38/

Achten Sie beim Aufhängen des Schrankes darauf, dass der Schrankaufhänger richtig in den Schraubhaken einrastet.

T9

Lassen Sie den Schrank nur durch fachkundige Personen mit für die Wand geeignetem Montagematerialien montieren.

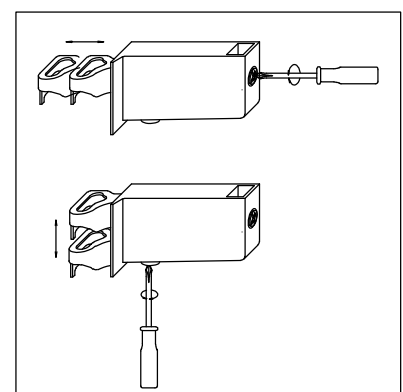
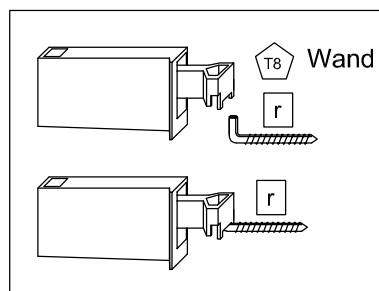

9.

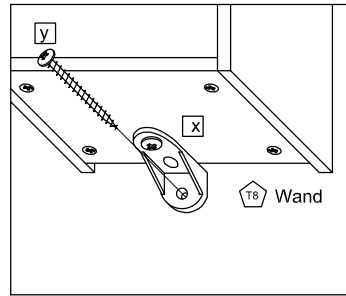
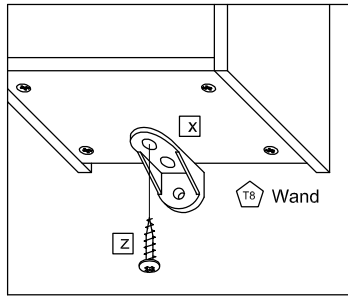
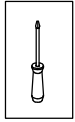

10.

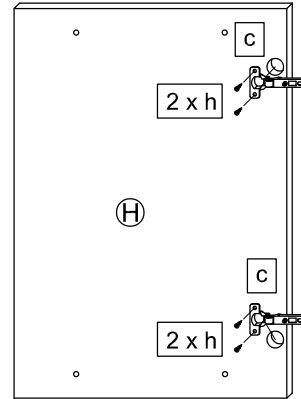
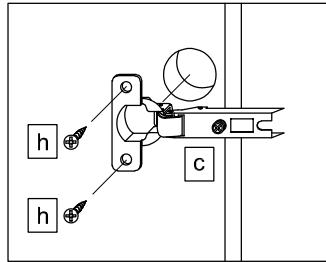
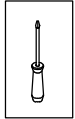

11.

A

B

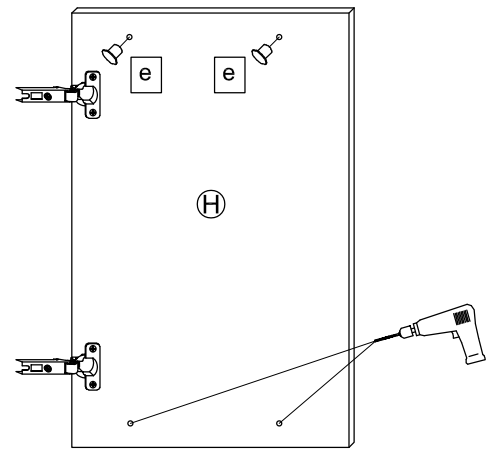
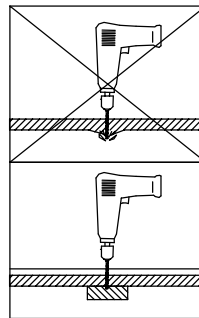
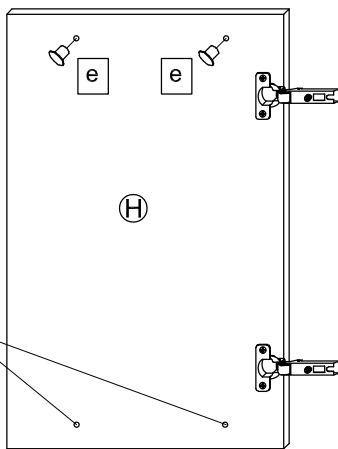
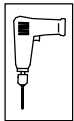

12.

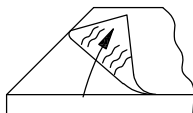
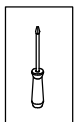

T10

Bei Hochglanz-Fronten bitte erst die Schutzfolie entfernen und dann den Griff montieren!

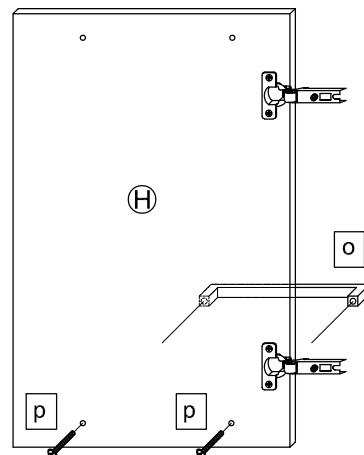

13.

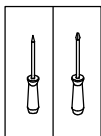

Bei Türmontage das Scharnier einhängen, bis Anschlag öffnen und anschließend festschrauben.

A

B

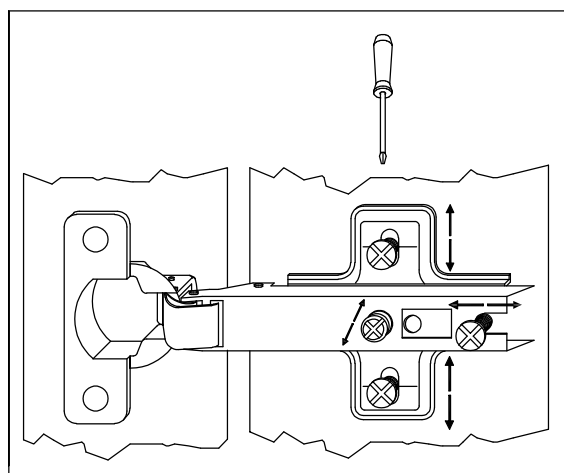
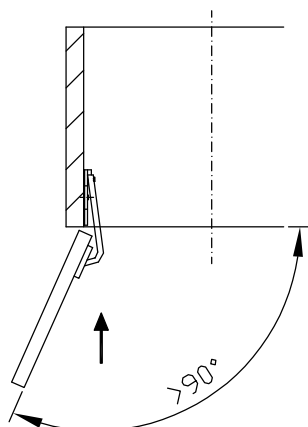
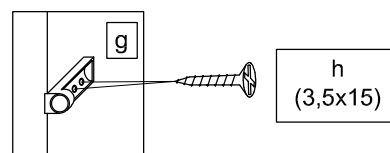
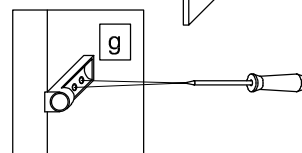
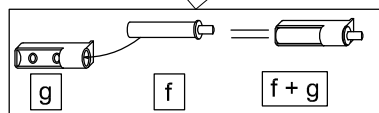
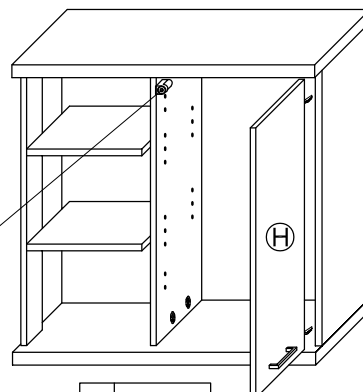
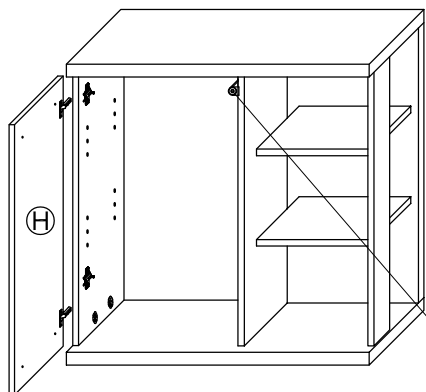

14.

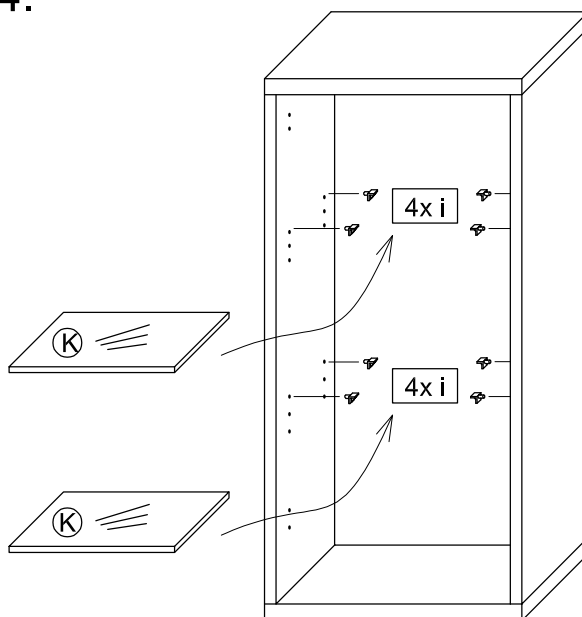

Das Möbel bitte nur mit einem feuchten Tuch reinigen.